



# HVAC UPGRADE PROJECT 1317 O STREET SACRAMENTO, CALIFORNIA 95814

## Section 1

### Bid Forms

The following documents are to be completed, executed, and submitted as a total bid proposal package:

- ❖ Project Checklist
- ❖ Notice to Contractors
- ❖ Bid Proposal
- ❖ Non-Collusion Declaration
- ❖ Subcontractor Form
- ❖ Evidence of Contractor DIR Wage Monitoring Registration (*for prevailing wage projects\*\**)
- ❖ All Bid Addenda (*if issued*)

**Failure to submit any of the above Bid Forms may render the bid Non-Responsive**

CADA bid packages contain the following three sections —

- **Section 1: The Bid Forms**, which must be returned as the “bid.”
- **Section 2: The Contract Documents**, which are provided for reference only.
- **Section 3: Other Required Documents** (such as licenses and insurance), which are required of the designated lowest responsive, responsible bidder prior to or at contract signing.

### **THE PROJECT SCOPE OF WORK IS CONTAINED IN SECTION 2, EXHIBIT A**

**For questions or assistance completing this bid package, or providing any of the required items, please contact Tara Gandara.**

\*\*In accordance with Sacramento City Code Section 3.60.180 and Section 1782 of the California Labor Code, the payment of the general prevailing rate of per diem wages or the general prevailing rate of per diem wages for holiday and overtime is NOT required for any project of \$15,000 or less.

Projects subject to payment of prevailing wage require evidence of contractor registration with the Department of Industrial Relations for wage monitoring to be included with the proposal. Failure to submit evidence of current registration will render the bid non-responsive.



## PROJECT CHECK LIST FOR BID PACKAGES

**Project:** HVAC UPGRADE PROJECT

**Address:** 1317 O Street

**Bid Walk Thru:** Friday, December 1, 2023 at 10:00am  
**Bid Open:** Thursday, December 14, 2023 at 2:15pm

**Location:** 1317 O Street  
**Location:** 1522 14<sup>th</sup> Street, Sacramento, CA

**CADA BID FORMS**

**SECTION 1: CONSTRUCTION BID PACKAGE (To be completed and submitted as bid)**

- Project Checklist
- Notice to Contractors
- Bid Proposal
- Non-Collusion Declaration
- Subcontractor Form
- Prevailing Wage Notice
- Evidence of DIR Contractor Registration (Lab. Code § 1725.5)
- All Bid Addenda (if issued)

**Failure to submit any of the above Bid Forms may render the bid Non-Responsive**

**SECTION 2: CONTRACT DOCUMENTS (For reference)**

- Contract
- Exhibit "A" Scope of Work, dated November 8, 2023
- Exhibit "A.1" Plan Drawings — 1 page
- Exhibit "B" Terms and Conditions

**SECTION 3: OTHER REQUIRED DOCUMENTS (required at contract signing)**

- Payment Bond 100%
- Performance Bond 100%
- Workers' Compensation Insurance Certification
- Warranty / Guarantee
- Any Change Orders or Contract Modifications (if issued)
- Unconditional Waiver and Release Upon Progress Payment
- Unconditional Waiver and Release Upon Final Payment
- Certificates of Insurance as required by Exhibit B – Terms & Conditions, section 39
- Required License Copies
- Apprenticeship Statement
- Form W-9 (Rev October 2018); Request for Taxpayer I.D. Certification
- Contractors Code of Conduct
- Asbestos-Free Materials Certification
- Recycled Content Certification (Pub. Cont. Code § 22152)

**Mandatory pre-bid job walk scheduled Friday, December 1, 2023 @ 10:00 a.m., located at 1317 O Street, Sacramento, California**

**\* Non-attendance at the mandatory pre-bid job walk will disqualify bidder \***

**Required Licenses:** California Contractor's License (C-20; or B – General Contractor); Valid City of Sacramento Business Operation Tax or County of Sacramento Business License.

**Questions regarding the bid package and contract should be directed to:**

Tara Gandara – 916-322-2114 | [TGandara@cadanet.org](mailto:TGandara@cadanet.org)

THIS CHECKLIST IS TO BE SUBMITTED WITH THE CONSTRUCTION BID PACKAGE. THE SIGNATURE OF THE BIDDER SIGNIFIES THAT THE BIDDER HAS REVIEWED THE CHECKLIST AND RECEIVED COPIES OF ALL OF THE DOCUMENTS LISTED THAT ARE INCLUDED AS INDICATED BY .

\_\_\_\_\_  
**Bidder's Signature**

\_\_\_\_\_  
**Date**



## NOTICE TO CONTRACTORS CAPITOL AREA DEVELOPMENT AUTHORITY

***CADA may waive any irregularity in the process except attendance at the mandatory pre-bid job walk through.***

Proposals will be received by the **CAPITOL AREA DEVELOPMENT AUTHORITY ("CADA")** at the CADA Administration Office, 1522 14<sup>th</sup> Street, Sacramento, California 95814, up to the hour of **2:15 P.M., THURSDAY, DECEMBER, 14, 2023** for:

### **HVAC UPGRADE PROJECT 1317 O Street Sacramento, California 95814**

as set forth **SCOPE OF WORK: See Exhibit "A" dated NOVEMBER 8, 2023, titled HVAC UPGRADE PROJECT, See Exhibit "A.1" PLAN DRAWINGS, 1 page; and see Exhibit "B" TERMS AND CONDITIONS, 16 pages.**

All such proposals received and any work performed thereunder must comply with Titles 18 through and including 26 of the Code of California Regulations as modified by this contract, and as may be further modified by the Executive Director of CADA by a written addendum at least five (5) days prior to the due date for this proposal. **If any Contractor desires a modification or has any questions, you shall request, in writing, such modification or questions prior to 3:00 p.m. on Friday, December 8, 2023,** to allow CADA to respond to said request. Bids must be submitted on printed forms supplied by CADA, without charge, to prospective bidders and enclosed in an envelope as noted below.

**BID DOCUMENTS TO BE PLACED INTO AN ENVELOPE MARKED AS FOLLOWS:  
"HVAC UPGRADE PROJECT @ 1317 O Street"**

**Mandatory pre-bid job walk scheduled for FRIDAY, DECEMBER 1, 2023 @ 10:00 a.m.  
LOCATION OF WALK THRU MEETING IS: 1317 O Street - Sacramento, CA 95814**

**\*Non-attendance at the mandatory pre-bid job walk will disqualify bidder\***

Bid packages may be obtained from the CADA website at <http://www.cadanet.org/working-with-cada/bids> or by request at 1522 14<sup>th</sup> Street, Sacramento, between the hours of 9:00 a.m. - 4:30 p.m., Monday through Friday, prior to the bid opening.

The Executive Director of CADA may, in her opinion, amend any bond form upon a written request by the bidder or the bidder's surety if said request is made within a sufficient period of time prior to the bid or proposal due date to allow CADA to respond to said request.

#### **PREVAILING WAGE NOTICE:**

All contractors, subcontractors, and all concerned must comply with the rate of wages per hour as established by the Director of the Department of Industrial Relations (DIR) under provisions of Sections 1770 and 1773 of the Labor Code of the State of California, or such other rate of wages as may hereafter be established by the Director of the Department of Industrial Relations in compliance with Section 1770 of the Labor Code of the State of California. In accordance with Sacramento City Code Section 3.60.180 and Section 1782 of the California Labor Code, **the payment of the general prevailing rate of per diem wages or the general prevailing rate of per diem wages for holiday and overtime is not required for any public construction projects of \$15,000 or less.**

❖ Notice to Contractors

Execute and return with bid packet

**EVIDENCE OF REGISTRATION WITH DIR REQUIRED FOR PREVAILING WAGE PROJECTS**

Pursuant to Labor Code section 1725.5, no contractor or subcontractor may be listed on a bid proposal for a public works project and no contractor or subcontractor may be awarded a contract for public work on a public works project unless registered with the DIR.

CADA reserves the right to request and receive payroll records during or after the completion of the project to verify compliance with Sections 1770 and 1773 of the Labor Code of the State of California or such other rate of wages as may hereafter be established by the Director of the Department of Industrial Relations in compliance with Section 1770 of the Labor Code of the State of California. Copies of the prevailing rate of per diem wages are on file at CADA's office and are available upon request or online at <http://www.dir.ca.gov/dlsr>.

**LATE OR FAXED BIDS WILL NOT BE ACCEPTED. INCOMPLETE BIDS MAY RENDER THE BID NON-RESPONSIVE.**

The right to reject any and all bids or to waive any informality in any bid received is reserved by CADA.

The award shall be made to the lowest responsible and responsive bidder, based on the lump sum amount provided on the Bid Proposal Form, provided that all specified bidding requirements have been met. Once the contract has been awarded to a bidder, the successful bidder then has ten (10) calendar days to provide CADA with a signed original contract along with all other required documents. If the above deadline is not adhered to, CADA reserves right to void the award, and award the contract to the next lowest bidder.

***Questions regarding the Scope of Work or bid package should be directed to:***

*Tara Gandara, CADA – 916-322-2114 | [TGandara@cadanet.org](mailto:TGandara@cadanet.org)*

**THIS NOTICE IS TO BE SUBMITTED WITH THE CONSTRUCTION BID PACKAGE.**

**THE SIGNATURE OF THE BIDDER SIGNIFIES THAT THE BIDDER HAS REVIEWED THE INFORMATION.**

**CAPITOL AREA DEVELOPMENT AUTHORITY**

\_\_\_\_\_  
Bidder's Signature



**BID PROPOSAL**  
**CAPITOL AREA DEVELOPMENT AUTHORITY**  
**Bid Due: Thursday, December 14, 2023 @ 2:15 P.M.**

*CADA may waive any irregularity in the process  
 EXCEPT attendance at the mandatory pre-bid job walk through*

**PROJECT:** HVAC UPGRADE PROJECT – 1317 O Street  
**WALK THRU:** Friday, December 1, 2023 at 10:00 a.m.  
**MEETING PLACE:** 1522 14<sup>TH</sup> Street, Sacramento, CA  
**BID OPEN:** Thursday, December 14, 2023 @ 2:15 p.m.

THE UNDERSIGNED, AS BIDDER, HEREBY PROPOSES AND AGREES THAT IF THIS BID IS ACCEPTED WITHIN NINETY (90) DAYS FOLLOWING THE BID OPENING DATE, CONTRACTOR WILL SIGN ALL CONTRACT DOCUMENTS AND FURNISH THE NECESSARY SURETY BONDS AND INSURANCE CERTIFICATES WITHIN TEN (10) DAYS AFTER AWARD OF THE CONTRACT AND FULLY PERFORM ALL THE WORK AND/OR FURNISH ALL MATERIALS, SUPERVISION, TRANSPORTATION, AND SUPPLIES AS SPECIFIED IN THE CONTRACT IN THE MANNER AND TIME PRESCRIBED, ACCORDING TO THE REQUIREMENTS AS THEREIN SET FORTH, AND ACCORDING TO THE SCOPE OF WORK SET FORTH.

**SCOPE OF WORK:** See Exhibit “A” dated NOVEMBER 8, 2023, titled HVAC UPDATE; See Exhibit “A.1” PLAN DRAWINGS (1) page, and **TERMS AND CONDITIONS:** See Exhibit “B” – 16 pages

**Bid:** \_\_\_\_\_ (\$ \_\_\_\_\_ . \_\_\_\_\_ )

In determining the contract award amount CADA reserves the right to add or deduct any alternate after the lowest responsible responsive bidder has been determined. The contract amount will be based on the base bid or the base bid plus the alternate.

The foregoing figure includes the cost of bond(s), insurance, sales tax, and every other item of expense incident to the contract. Field work will be completed within **(90) CALENDAR DAYS** from the date of commencement of work.

BOND REQUIREMENTS	REQUIRED	NOT REQUIRED
<b>1. Bid Bond</b> — (10%) of the contract price — <i>(due with proposal)</i> <i>Accepted in form of a bond, cashier's check, or money order</i>		<b>X</b>
<b>2. Payment Bond*</b> — Must be completed on the form attached hereto	<b>X</b>	
<b>3. Performance Bond*</b> — Must be completed on the form attached hereto	<b>X</b>	

\* Payment and Performance Bonds will be required of selected contractor following Notice of Award

**BY SIGNATURE UPON THIS PROPOSAL,** I declare under penalty of perjury that the foregoing is true and correct, and that I accept all terms stated above.

Signed \_\_\_\_\_ this \_\_\_\_\_ day of \_\_\_\_\_, **2023**, at \_\_\_\_\_, California.

**PLEASE PRINT INFORMATION BELOW LEGIBLY**

By \_\_\_\_\_ Of \_\_\_\_\_  
 (Name and title) (Company Name)

Contractor's License No. \_\_\_\_\_ is held by the bidder, is current and active.

The Contractor's License Classification is \_\_\_\_\_ and the expiration date is \_\_\_\_\_.

Type of Ownership \_\_\_\_\_ State of Incorporation \_\_\_\_\_

❖ Bid Proposal complete, execute, and return with bid packet

Full names of partners or officers \_\_\_\_\_

\_\_\_\_\_

Company Address including Zip Code \_\_\_\_\_

Company Phone \_\_\_\_\_ Contact Email \_\_\_\_\_

Company Taxpayer Id \_\_\_\_\_

Workers' Comp \_\_\_\_ Yes \_\_\_\_ No Exp Date \_\_\_\_\_

Workers' Compensation Carrier Name and Policy #:  
\_\_\_\_\_  
\_\_\_\_\_

Are you certified with the State of California as an Emerging Small Business? \_\_\_\_\_ Yes \_\_\_\_\_ No

Address bids to: **CAPITOL AREA DEVELOPMENT AUTHORITY**  
**1522 14<sup>th</sup> Street**  
**Sacramento, CA 95814**

Re: HVAC Upgrade Project @ 1317 O Street



**CAPITOL AREA DEVELOPMENT AUTHORITY  
NON-COLLUSION DECLARATION TO BE EXECUTED BY BIDDER  
AND SUBMITTED WITH BID\***

State of California,  
County of Sacramento

The undersigned declares:

I am the \_\_\_\_\_ of \_\_\_\_\_, the party making the foregoing bid.

The bid is not made in the interest of, or on behalf of, any undisclosed person, partnership, company, association, organization, or corporation. The bid is genuine and not collusive or sham. The bidder has not directly or indirectly induced or solicited any other bidder to put in a false or sham bid. The bidder has not directly or indirectly colluded, conspired, connived, or agreed with any bidder or anyone else to put in a sham bid, or to refrain from bidding. The bidder has not in any manner, directly or indirectly, sought by agreement, communication, or conference with anyone to fix the bid price of the bidder or any other bidder, or to fix any overhead, profit, or cost element of the bid price, or of that of any other bidder. All statements contained in the bid are true. The bidder has not, directly or indirectly, submitted his or her bid price or any breakdown thereof, or the contents thereof, or divulged information or data relative thereto, to any corporation, partnership, company, association, organization, bid depository, or to any member or agent thereof, to effectuate a collusive or sham bid, and has not paid, and will not pay, any person or entity for such purpose.

Any person executing this declaration on behalf of a bidder that is a corporation, partnership, joint venture, limited liability company, limited liability partnership, or any other entity, hereby represents that he or she has full power to execute, and does execute, this declaration on behalf of the bidder.

I declare under penalty of perjury under the laws of the State of California that the foregoing is true and correct and that this declaration is executed on \_\_\_\_\_[date], at \_\_\_\_\_[city], \_\_\_\_[state].”

\_\_\_\_\_  
Bidder's Signature

**\*NOTE:** Bidder's failure to complete this form and submit it with the bid may subject Bidder to disciplinary action pursuant to Section 7115 of the California Business and Professions Code.

Complete, execute, and return with bid packet

Non-Collusion Declaration

## SUBCONTRACTOR FORM

In accordance with the Subletting and Subcontracting Fair Practices Act (Public Contract Code Sections 4100, seq.), the following information is required concerning proposed subcontractors who will accomplish more than one-half of one percent of the prime contractor's total bid. No subcontractor may be substituted in place of a subcontractor listed in the original bid except as approved by the Authority in accordance with Public Contract Code Section 4107. **Note: If no subcontractors are proposed, please list – "NONE" and return this form.**

Name Subcontractor	Street Address of Shop, Mill or Office	Types of Work/Category of Contract	\$ Value of Work to be Done	Subcontractor's License Number	License Type/Expiration Date
<b>IF NO SUBCONTRACTORS WILL BE USED – <span style="background-color: yellow;">COMPLETE THIS FORM</span> AND WRITE "NONE" HERE: _____</b>					
<b>SIGNATURE _____ DATE _____</b>					

I declare under penalty of perjury that the foregoing is true and correct and this Declaration is executed this \_\_\_\_\_ day of \_\_\_\_\_, 2023, in Sacramento, CA 95814

Company Name \_\_\_\_\_

By: \_\_\_\_\_  
Contractor Name (Printed or Typed)

**SUBCONTRACTOR FORM MUST BE RETURNED WITH BID**

Complete, execute, and return with bid





# CADA FISCAL YEAR 2023-2024 HVAC UPGRADE PROJECT

## PREVAILING WAGE REQUIREMENTS

In accordance with Sacramento City Code Section 3.60.180 and Section 1782 of the California Labor Code, the payment of the general prevailing rate of per diem wages or the general prevailing rate of per diem wages for holiday and overtime is NOT required for any project of \$15,000 or less.

Projects subject to payment of prevailing wage will require evidence of contractor registration with the Department of Industrial Relations for wage monitoring to be submitted with this form. Failure to submit evidence of current registration will render the bid non-responsive.

**Proposals submitted in excess of \$15,000.01 require evidence of registration with the Department of Industrial Relations for wage monitoring to be submitted in addition to this signed form. Failure to submit evidence of current registration will render the bid non-responsive.**

Proposals submitted for \$15,000 or less are still required to sign this form and must be included with the bid proposal.

Signed: \_\_\_\_\_ Date: \_\_\_\_\_

**PLEASE PRINT INFORMATION BELOW LEGIBLY**

By: \_\_\_\_\_ Of: \_\_\_\_\_  
(Name and title) (Company Name)

Public Works Contractor Registration (PWCR) Number: \_\_\_\_\_

❖ Prevailing Wage Notice

Execute and return with bid packet

Include Proof of DIR registration, if required



# HVAC UPGRADE PROJECT 1317 O STREET SACRAMENTO, CALIFORNIA 95814

THE PROJECT SCOPE OF WORK IS CONTAINED IN EXHIBIT A

## SECTION 2

### CONTRACT DOCUMENTS:

**PROVIDED FOR  
REFERENCE ONLY**

The project Scope of Work is included as Exhibit A. Proposal pricing is to be based on the Scope of Work and includes the cost of bond(s), insurance, sales tax, and every other item of expense incident to the contract.

**If awarded the contact, please be prepared to complete and sign all of the contract documents.**

Upon NOTICE OF AWARD, the Contractor will be provided with a completed contract, be required to provide all mandatory documentation, and execute all included contract documents.

Once the contract has been signed and all the required documents provided, it will be assembled, executed, and contractor will be provided a copy.

Contract # C24-\_\_\_\_

**CAPITOL AREA DEVELOPMENT AUTHORITY  
CONTRACT FOR CONSTRUCTION, REHABILITATION AND REPAIRS  
HVAC UPGRADE PROJECT  
1317 O Street  
Sacramento, CA**

THIS CONTRACT is entered into this \_\_\_\_ day of \_\_\_\_\_ 2023, by and between, the **CAPITOL AREA DEVELOPMENT AUTHORITY**, a joint powers agency, hereinafter referred to as "**CADA**", and \_\_\_\_\_ hereinafter referred to as "Contractor".

**CADA AND CONTRACTOR AGREE AS FOLLOWS:**

**1. CONTRACT DOCUMENTS**

This contract consists of the following documents which are collectively referred to as "the contract documents" or "the contract," each of which is incorporated herein.

**CONTRACT, SCOPE & TERMS**

- Contract
- Exhibit "A" Scope of Work, dated November 8, 2023
- Exhibit "A.1" Plan Drawings
- Exhibit "B" Terms and Conditions
- Any Change Orders or Contract Modifications (if issued)
- Bid Proposal
- All Bid Addenda (if issued)
- Non-Collusion Declaration
- Subcontractor Form
- Prevailing Wage Notice

**OTHER REQUIRED DOCUMENTS**

- Payment Bond 100%
- Performance Bond 100%
- Workers' Compensation Insurance Certification
- Warranty – Guarantee
- Unconditional Waiver & Release Progress Payment
- Unconditional Waiver & Release upon Final Payment
- Certificates of Insurance  
*as required by Exhibit B – Terms & Conditions, section 39*
- Required License and Certificate Copies
- Evidence of Contractor DIR Wage Monitoring Registration  
*As required by Labor Code § 1725.5*
- Apprentice Statement
- Form W-9; Request for Taxpayer I.D. Certification
- Contractors Code of Conduct
- Asbestos-Free Materials Certification
- Recycled Content Certification (Pub. Cont. Code § 22152)

The bidder agrees to furnish all tools, equipment, apparatus, facilities, labor, material and transportation necessary to perform, and complete in a good and workmanlike manner to the satisfaction of CADA, all work or services as described in the contract documents. All work completed shall be completed in strict conformity with the contract documents.

**2. TERM OF CONTRACT**

Contractor shall commence the performance of the work described in this contract: (check one)

- a. Within 10 days after receipt by Contractor of a written "Notice to Proceed";
- b. Within \_\_\_\_\_ days after execution of this contract. (Weather permitting)

Materials to be ordered upon receipt of Notice of Award. The Contractor shall complete the field work within in **(90) calendar days** from the date of commencement as set forth in either "a" or "b" above, whichever is applicable. (**Weather permitting**)

**3. COMPENSATION AND METHOD OF PAYMENT**

In accordance with Sacramento City Code Section 3.60.180 and Section 1782 of the California Labor Code, the payment of the general prevailing rate of per diem wages or the general prevailing rate of per diem wages for holiday and overtime is not required for any public construction projects of \$15,000 or less.

**This project:**

- is subject to prevailing wage requirements
- is NOT subject to prevailing wage requirements

The total amount paid to Contractor under this Contract shall not exceed the sum of:

\_\_\_\_\_ (\$ \_\_\_\_\_ )

- In a lump sum when the contract work is complete; or
- In progress payments as follows.

Contractor shall receive a 95% lump sum payment upon completion and final inspection of assignment by the Authority's Project Architect, and upon receipt of an approved invoice by the Authority's accounting office. The final 5% payment shall be paid in accordance with subsection (c).

In the event payment is made as progress payments, the following shall apply:

- (a) On or about the first day of each and every month, Contractor shall submit a statement to Authority setting forth the amount of labor and material incorporated in the work for the preceding month.
- (b) If Authority approves such statement, it shall pay to Contractor a sum equal to ninety five percent (95%) of the amount due.
- (c) Authority shall pay the remaining five percent (5%) of the value of the work, if unencumbered, thirty-five (35) days after final completion and acceptance of the work by Authority. Acceptance of final payments shall constitute a waiver of all claims against Authority arising under the contract documents.
- (d) Notwithstanding the foregoing, if this project is financed through a private financial institution which requires a foundation endorsement to title insurance before making advances on the loan, then any progress payment related to the foundation endorsement may be delayed until the foundation Endorsement is obtained. If any such delay shall occur, Contractor shall not receive any compensation for such delay, provided Authority shall diligently apply for such foundation endorsement and act in good faith to obtain such endorsement.
- (e) Contractor agrees to provide CADA with a conditional lien release, for final payment prior to CADA'S issuance of a final payment.

**4. SUBCONTRACT**

The Contractor shall not assign this contract or subcontract with any subcontractor to perform any services or scope of work set forth in this contract, unless Contractor has first received CADA's written approval.

If the CADA grants such approval, it will be limited to the work and timeframe described.

If the CADA approves any subcontractors, the subcontractor shall be given a copy of this contract by the contractor to be familiar to all terms and requirements, and shall be bound by the same. The Contractor agrees to require that the subcontractor provide the CADA with Certificates of Insurance and any required endorsements as outlined in Exhibit B, Section 39, prior to utilizing their services.

**5. APPLICABLE LAW**

The parties hereto understand and agree that the terms of this Contract, have been negotiated and executed within the State of California and shall be governed and construed under the laws of the State of California. In case of a dispute concerning the terms of this contract, the parties hereto expressly agree that the venue for any legal action shall be with the appropriate court in the County of Sacramento, State of California.

**6. LIQUIDATED DAMAGES**

The actual fact of the occurrence and the actual damages which Authority would suffer if the work were not completed within the specified time set forth are dependent upon many circumstances and conditions which could prevail in various combinations, and from the nature of the case, it is impracticable and extremely difficult to fix the actual damages. Damages which Authority would suffer in the event of delay include expenses of prolonged employment of an architectural and engineering staff; costs of administration, inspection and supervision; and the loss suffered by the public within the Capitol Area by reasons of the delay in the completion of the project to serve the public at the earliest possible time. Accordingly the parties hereto agree, that they understand, have ascertained and agree, that the amounts set forth herein as sustained by the failure of Contractor to complete the entire work within the time specified represent a proper determination for the liquidated damages. The amount of the liquidated damages to be paid by Contractor to Authority for failure to complete the entire work by the completion date will be **One Hundred Fifty Dollars and 00/100 (\$150.00)** each calendar day beyond the completion date.

**7. INSURANCE**

Contractor shall maintain the following insurance coverage limits for each applicable insurance category as described in Paragraph 39 of the Standard Terms and Conditions.

**8. AUTHORITY TO EXECUTE**

**Each person signing this contract warrants that he or she is authorized to enter into this Contract either by company position or on behalf of his or her principal.**

By signature below, the parties named, herein accept and agree to all terms of this contract, and agree that this will be considered fully executed as indicated as of the date signed by CADA. This contract is executed in the County of Sacramento, in the State of California.

**CAPITOL AREA DEVELOPMENT AUTHORITY:**

**CONTRACTOR NAME:**

By: \_\_\_\_\_  
Danielle Foster  
Executive Director  
1522 14<sup>th</sup> Street  
Sacramento, CA 95814

By: \_\_\_\_\_  
Name, Title  
Address  
City and State and Zip  
Phone: \_\_\_\_\_  
Email: \_\_\_\_\_  
License: \_\_\_\_\_

Date: \_\_\_\_\_

Date: \_\_\_\_\_

Federal Tax ID: \_\_\_\_\_

**EXHIBIT A - Scope of Work**  
**CAPITOL AREA DEVELOPMENT AUTHORITY**

**HVAC Unit Upgrade Project**  
**1317 O Street**  
**Sacramento, CA**

November 8, 2023

1. Contractor shall furnish the necessary labor, materials, tools and equipment to perform the following Work consistent with all federal, state and local law and building code regulations.

**Materials: Contractor must make sure the materials are acquired and ready to install prior to work. Please include any expedited freight fees in your bid to ensure that the materials arrive in a timely manner to meet the deadline.**

2. **The Work:** The term “Work” means the construction and services required by the Contract Documents whether completed or partially completed, and includes all other labor, materials, equipment and services provided or to be provided by the contractor to fulfill Contractors obligations. Contractor shall fully execute the Work described in the contract documents except to the extent specifically indicated in the Contract Documents to be the responsibility of others.

The Work shall consist of, but not limited to the following:

**A. 1317 O Street**

- 1) The Contractor is to remove the (17) existing wall units, heat-pumps that serve the 17 Residential units in the building. Supply (17) New Split units, 17 seer, or better, 14K BTU, or better, 110 volt, mounted to the side of the building where you removed the in-wall units. Install (1) head per unit, as close to the current outlet is in each unit.
- 2) Contractor will be responsible to remove the AC cans and repair the stucco to make it water tight. Painting the stucco and Drywall inside will be CADA’s responsibility.
- 3) Use the current dedicated line for each split unit, 1- 20-amp breaker per unit. Notify the CADA Construction Manager, Frank Czajka or the Facilities Maintenance Manager, Russ Juneau.
- 4) The Contractor will provide proper start-up and deliver a fully functioning system.
- 5) The Contractor will be responsible for the proper disposal of the old units.
- 6) modifications must be approved by CADA’s Construction Manager or the Facilities Maintenance Manager.

Initial \_\_\_\_\_

## EXHIBIT A - Scope of Work

### Terms:

If encountered after the Mandatory Job Walk, Bidding Contractors are responsible to submit any questions regarding the project scope to the **CADA Construction Services Manager, Frank Czajka**, by the deadline set forth in contract documents. Questions are to be submitted in writing via email to [fczajka@cadanet.org](mailto:fczajka@cadanet.org). Phoned questions will not be accepted. All questions will be answered via addendum, emailed to the email addresses provided by bidding contractors on the Mandatory Job Walk Sign-in Sheet.

Upon approval of the winning bid, by CADA's Board of Directors, the work must be completed by June 2024,

CADA is to be notified, via email or in person, 48 hours prior to commencement of field Work for this contract.

The Contractor will work with CADA's Construction Manager, Frank Czajka on the scheduling of the work.

Contractor shall verify all items on the job site to familiarize himself/herself with the contract Work.

Contractor shall notify CADA if any discrepancies are found within the scope of Work, drawings or specifications, or if any alternates to scope, drawings or specifications are necessary, before the Work begins/proceeds.

Contractor shall keep the site clean and orderly during and after working hours.

Contractor shall provide and use all means necessary to ensure the physical Work to be performed is within construction standards and safety requirements as set by General Safety Orders of Title 8, California Code of Regulations, and set by CAL-OSHA requirements.

Project must comply with City Noise Control Ordinances, working hours to be between 8:00AM and 5:00PM, Monday through Friday. No weekend Work allowed. All premises may be occupied by CADA Tenants during construction.

NO WORK is to commence before a contract is fully executed, all insurance requirements are met, and certificates are on file with the CADA Contracts and Insurance Administrator.

The contractor shall participate in a project start up meeting. A Work Schedule is due upon the start of the project.

Initial \_\_\_\_\_



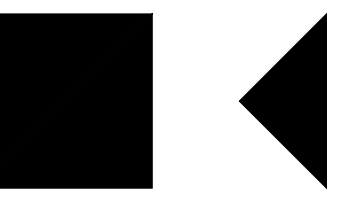

*Alexander Schefflo*



**MECHANICAL FLOOR PLAN  
KEYNOTE SCHEDULE**

- ① WALL MOUNTED FAN COIL UNIT WITH REFRIGERANT LINES WITH SIZES AS INDICATED WITHIN REFRIGERANT PIPE SIZE SCHEDULE ON THIS SHEET. REFER TO FAN COIL MOUNTING DETAILS.
- ② WALL MOUNTED HEAT PUMP MOUNTED ON EXTERIOR WALL. REFER TO DETAIL 6/MP&J FOR APPROXIMATE LOCATION.
- REFER TO WALL HEAT PUMP MOUNTING DETAIL.
- ③ EXTEND REFRIGERANT PIPE WITH SIZE AS INDICATED WITHIN REFRIGERANT PIPE SIZE SCHEDULE ON THIS SHEET. REFER TO REFRIGERANT PIPE INSULATION AND SPECIFICATION DETAIL.
- ④ WIRELESS FAN COIL THERMOSTAT MOUNTED WITH TOP AT 48" AFF.

**PLUMBING FLOOR PLAN  
KEYNOTE SCHEDULE**

- ① PROVIDE REQUIRED TRANSITION FITTING TO 3/4" O.D. DRAIN CONNECTION ON FAN COIL INCREASING IT TO 3/4". EXTEND THRU WALL AND CONNECT TO VERTICAL CONDENSATE DRAIN RISER. REFER CONDENSATE RISER DETAIL.
- ② PROVIDE 1/2" DRAIN CONNECTION AT DRAIN PAN UNDER EXTERIOR WALL HEAT PUMP. CONNECT TO VERTICAL CONDENSATE DRAIN RISER. REFER TO CONDENSATE RISER DETAIL.
- ③ SPILL 3/4" CD TO DRYWELL. REFER TO DETAIL.

MECHANICAL LEGEND	
SYMBOL	DESCRIPTION
①	KEY NOTE DESIGNATION
⊕	THERMOSTAT
-RL-RS-	REFRIGERANT LIQUID, SUCTION
FC	FAN COIL UNIT
HP	HEAT PUMP

PLUMBING LEGEND	
SYMBOL	DESCRIPTION
-CD-	CONDENSATE DRAIN

**REFRIGERANT PIPE SIZE SCHEDULE**

SPLIT SYSTEMS MARK NUMBERS	TONNAGE	REFRIGERANT PIPE SIZE	
		SUCTION	LIQUID
FC-1 / HP-1	1.5	5/8"	3/8"

- 1) PROVIDE 3/4" (RES) PIPE INSULATION ON REFRIGERANT PIPE LINES PER 2022 BUILDING ENERGY EFFICIENCY STD.
- 2) PROVIDE PROTECTION OF REFRIGERANT LINES FROM DAMAGE PER 2022 OMC REQUIREMENTS.

**MECHANICAL GENERAL NOTES**

- 1. MECHANICAL CONTRACTOR TO COORDINATE W/ ELECTRICAL PLUMBING AND FIRE SPRINKLER CONTRACTOR'S TO ELIMINATE ANY SPACE CONFLICTS.
- 2. ALL THERMOSTATS / SENSORS SHALL BE MOUNTED WITH TOP OF THERMOSTAT AT 48" AFF.
- 3. REFER TO 2022 CALIFORNIA GREEN CODE NOTES ON SHEET MP&J.

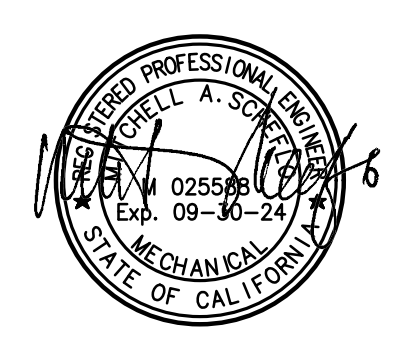

**ALEXANDER SCHEFFLO and ASSOCIATES, Inc.**  
Mechanical Engineers (209) 948-9761  
2926 Pacific Ave. Stockton, Ca. 95204

ALL DRAWINGS AND WRITTEN MATERIAL APPEARING HEREIN CONSTITUTE THE ORIGINAL AND UNPUBLISHED WORK OF THE ENGINEER AND THE SAME MAY NOT BE USED, REPRODUCED OR DISCLOSED WITHOUT THE WRITTEN CONSENT OF THE ENGINEER.  
© Alexander Schefflo & Assoc., Inc

1317  
O STREET

1317 O STREET  
SACRAMENTO, CA 95814

MECHANICAL  
FLOOR PLANS

DATE	NO.	MEMO	BY	APP.
APPROVED				MS
DRAWN				JJ
PROJECT NO.	23774			
DATE	OCTOBER 10, 2023			

**MP2.1**

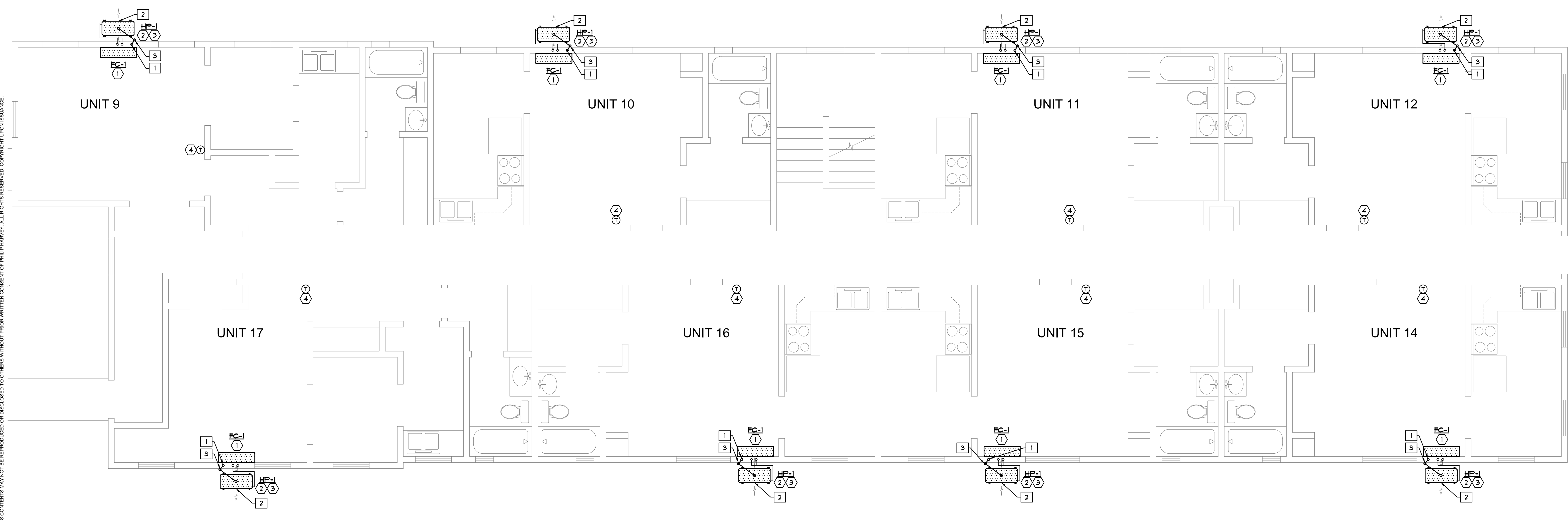

**MECHANICAL SECOND FLOOR PLAN**  
SCALE: 1/4"=1'-0"

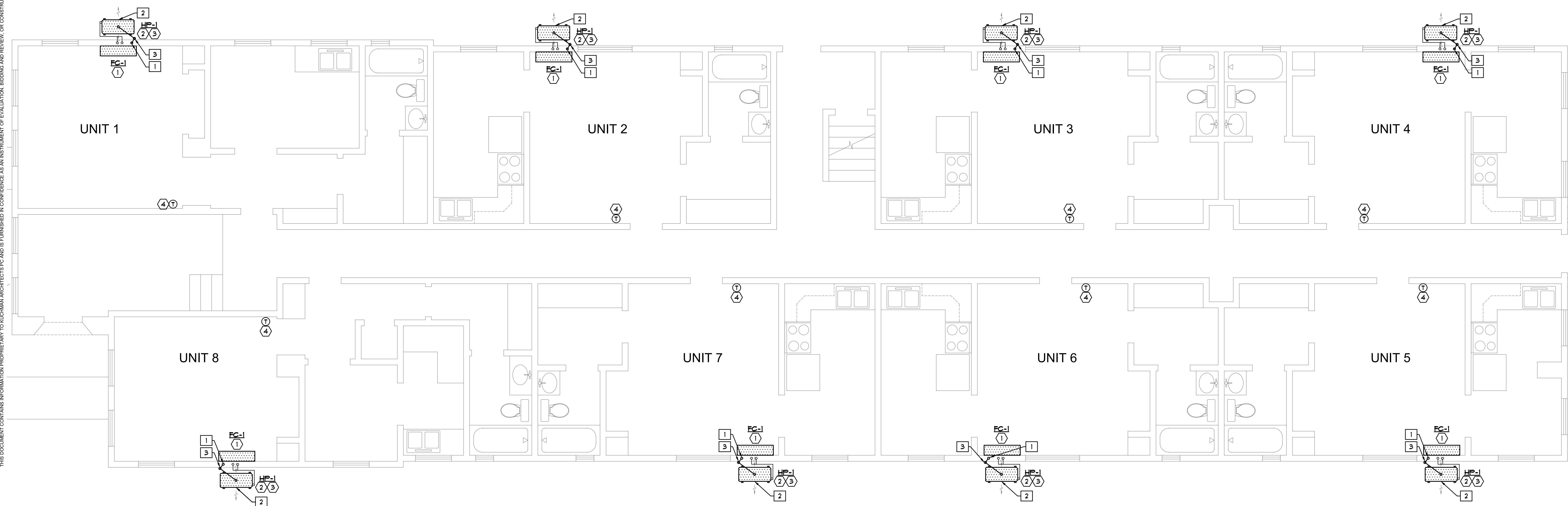

**MECHANICAL FIRST FLOOR PLAN**  
SCALE: 1/4"=1'-0"

THIS DOCUMENT CONTAINS INFORMATION PROPRIETARY TO KUCHMAN ARCHITECTS PC AND IS HEREBY CONFESSED AS AN INSTRUMENT OF EVALUATION, BOARDING AND REVIEW, OR CONSTRUCTION OF A SPECIFIC PROJECT. THIS DOCUMENT OR ITS CONTENTS MAY NOT BE REPRODUCED OR DISCLOSED TO OTHERS WITHOUT THE WRITTEN CONSENT OF KUCHMAN ARCHITECTS PC. ALL RIGHTS RESERVED. COPYRIGHT 2023 KUCHMAN ARCHITECTS PC.



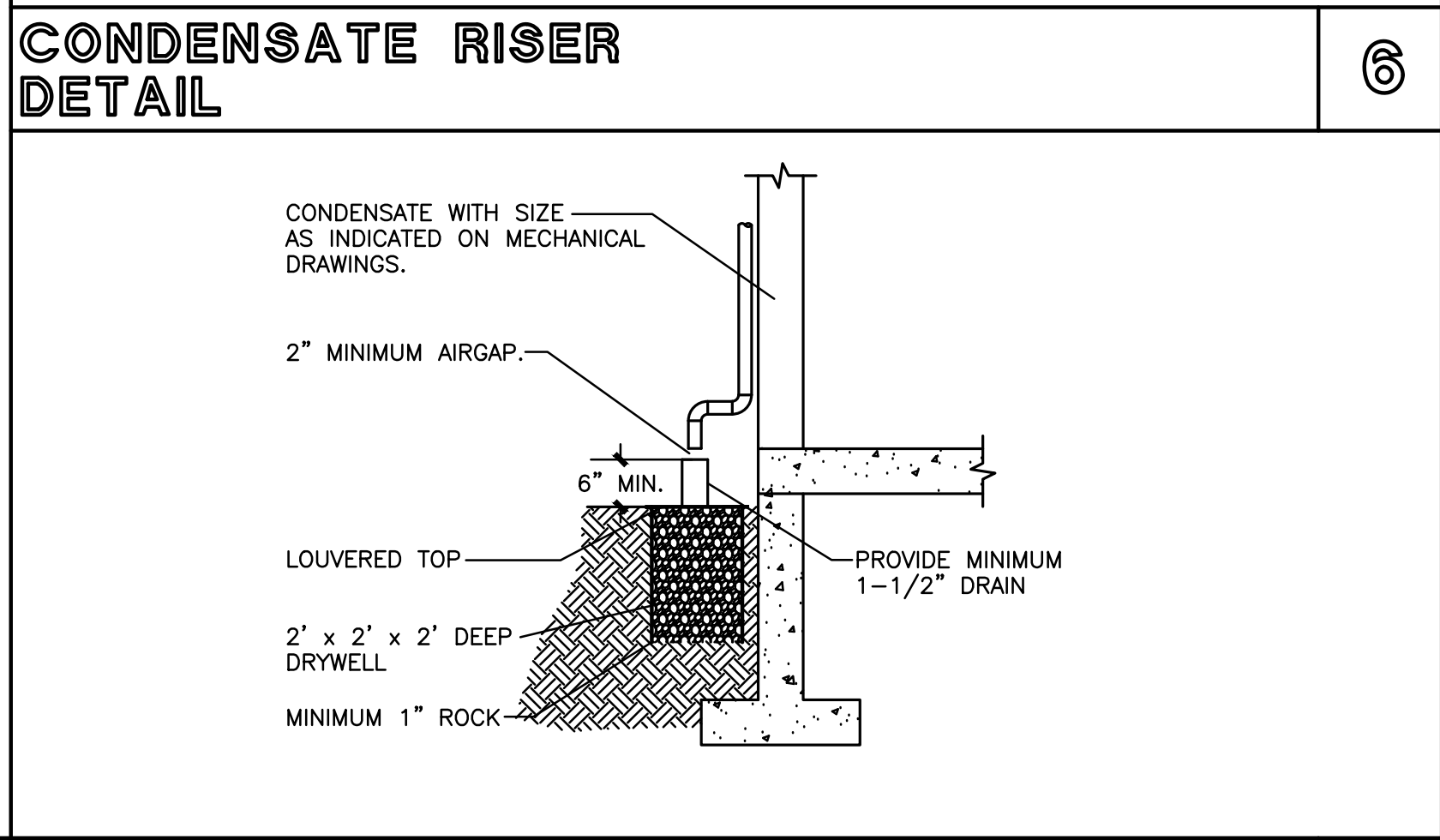
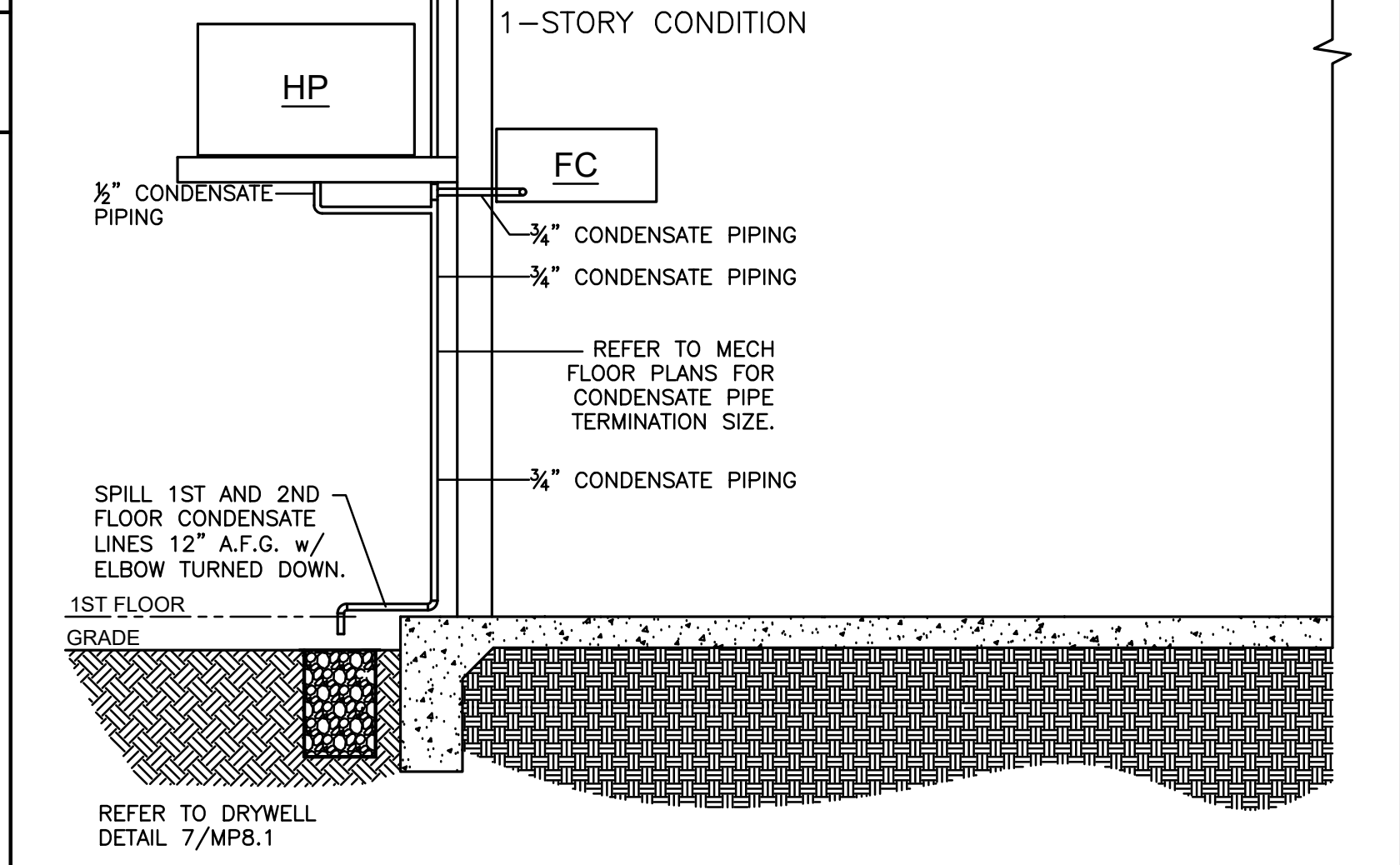
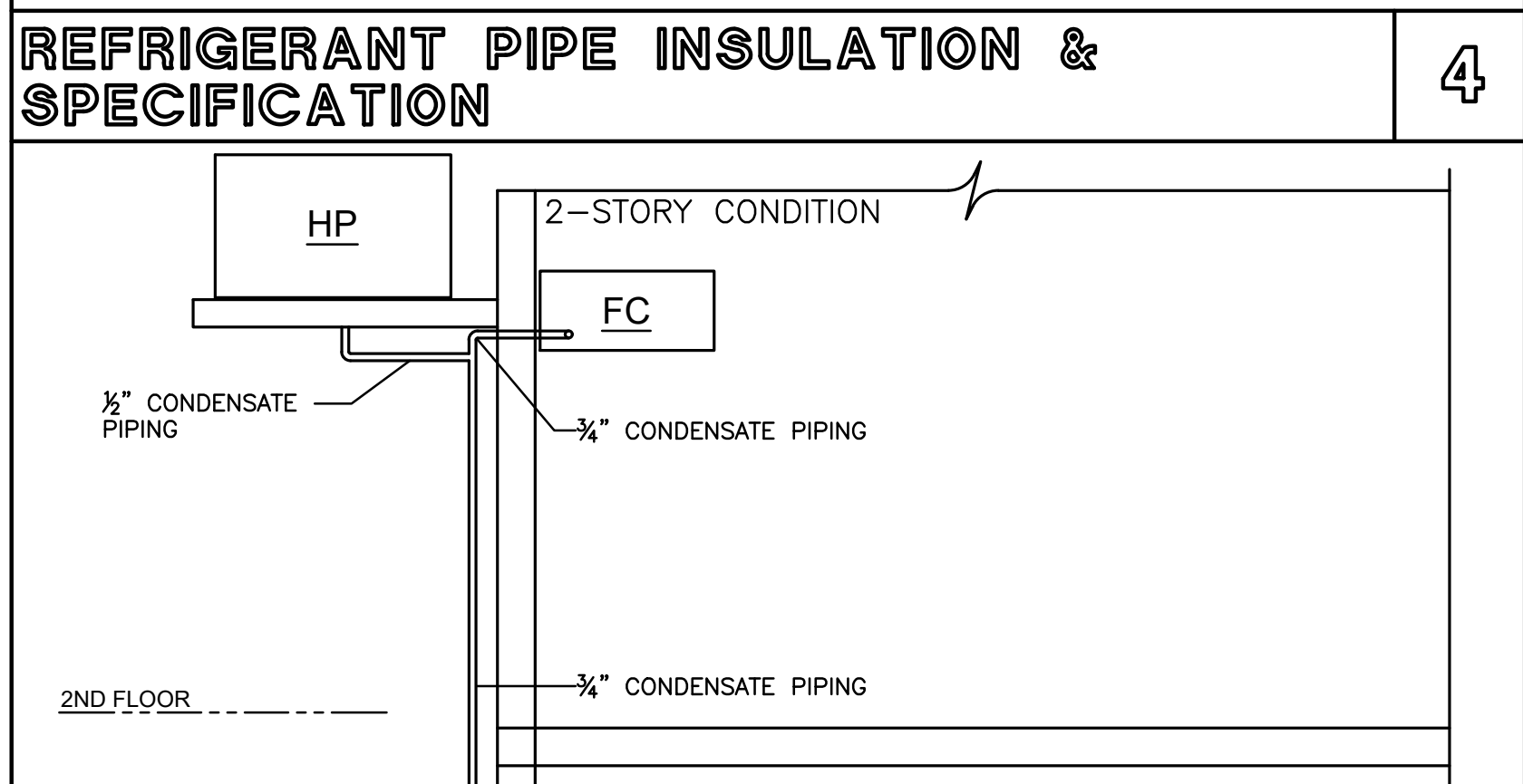
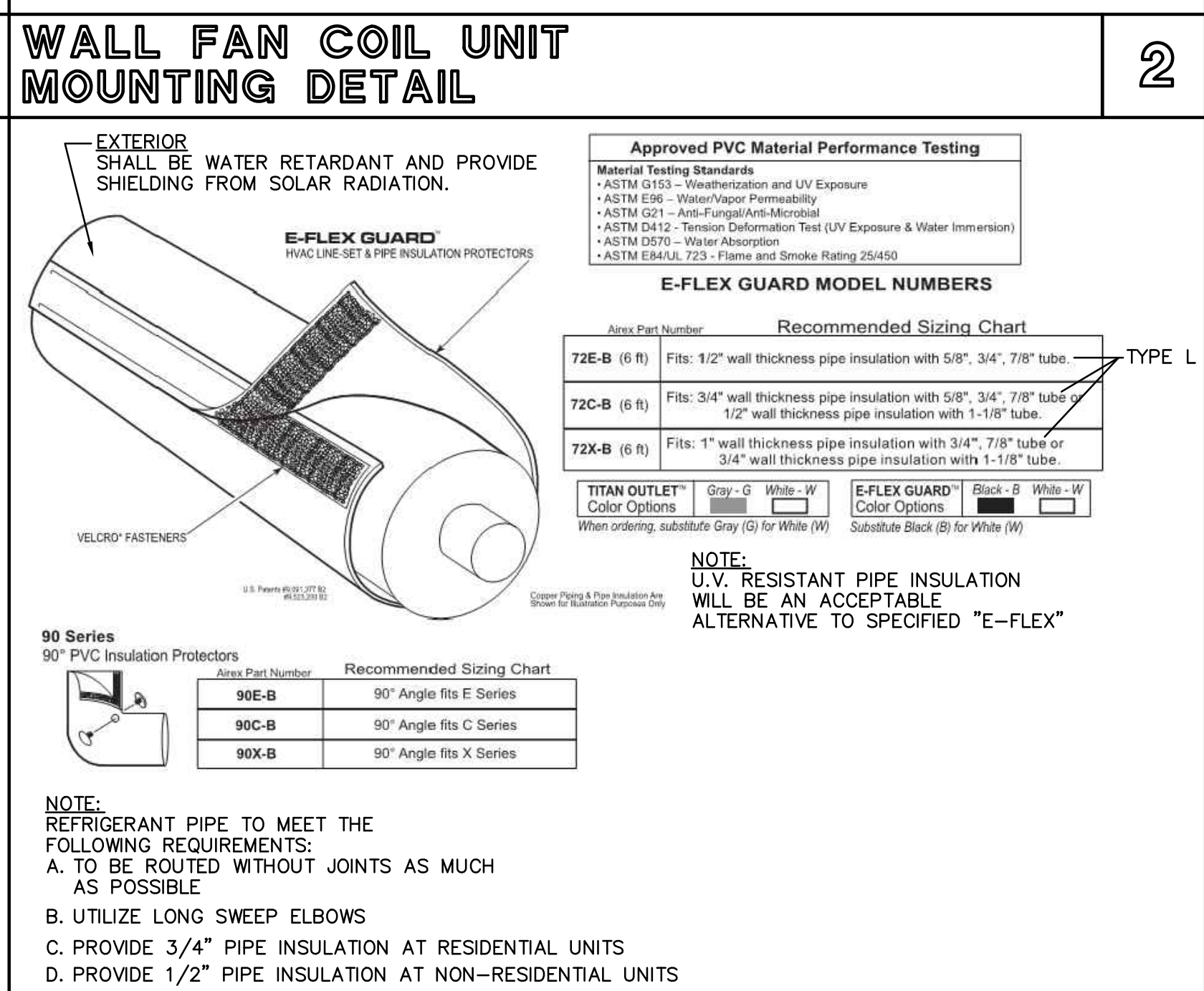
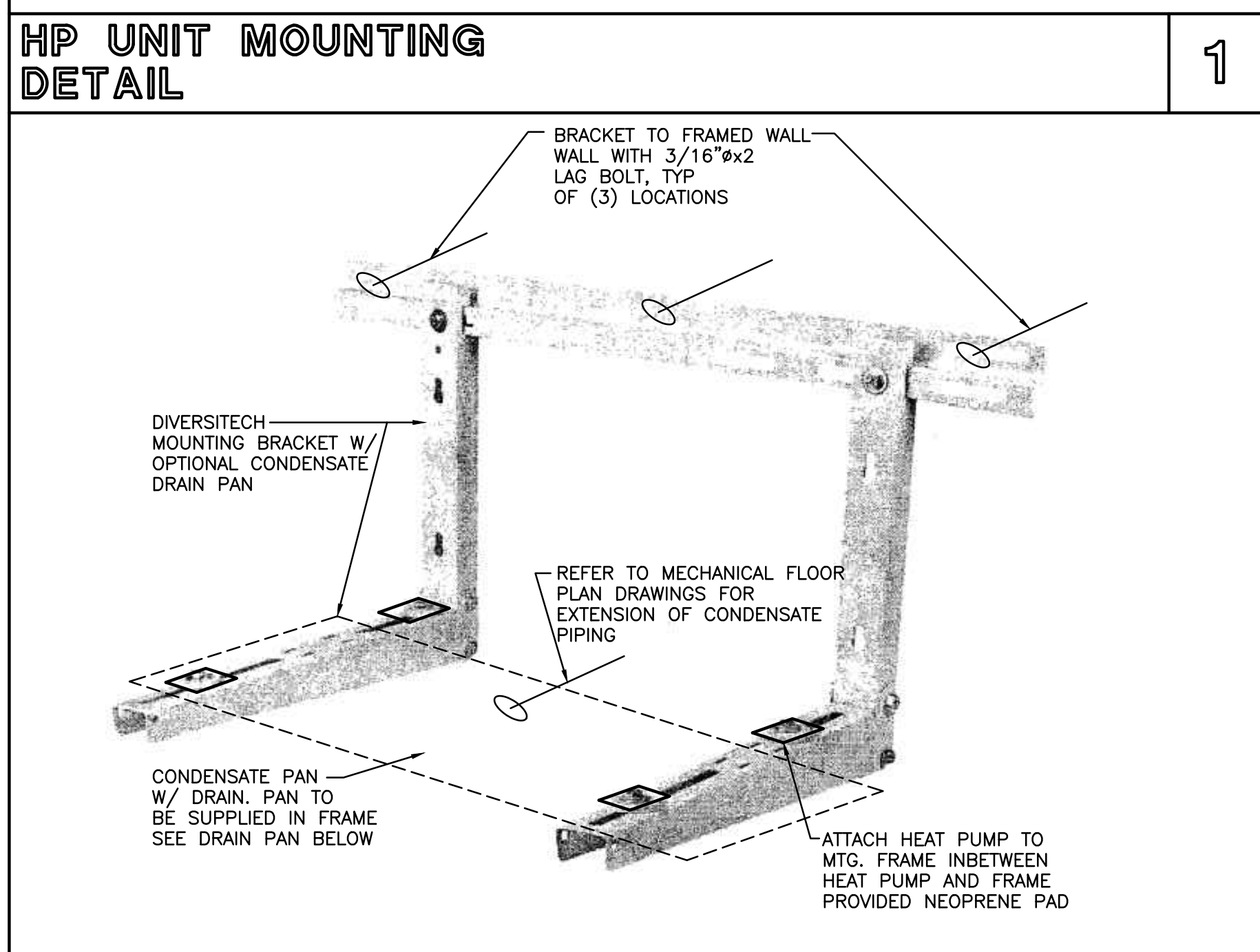
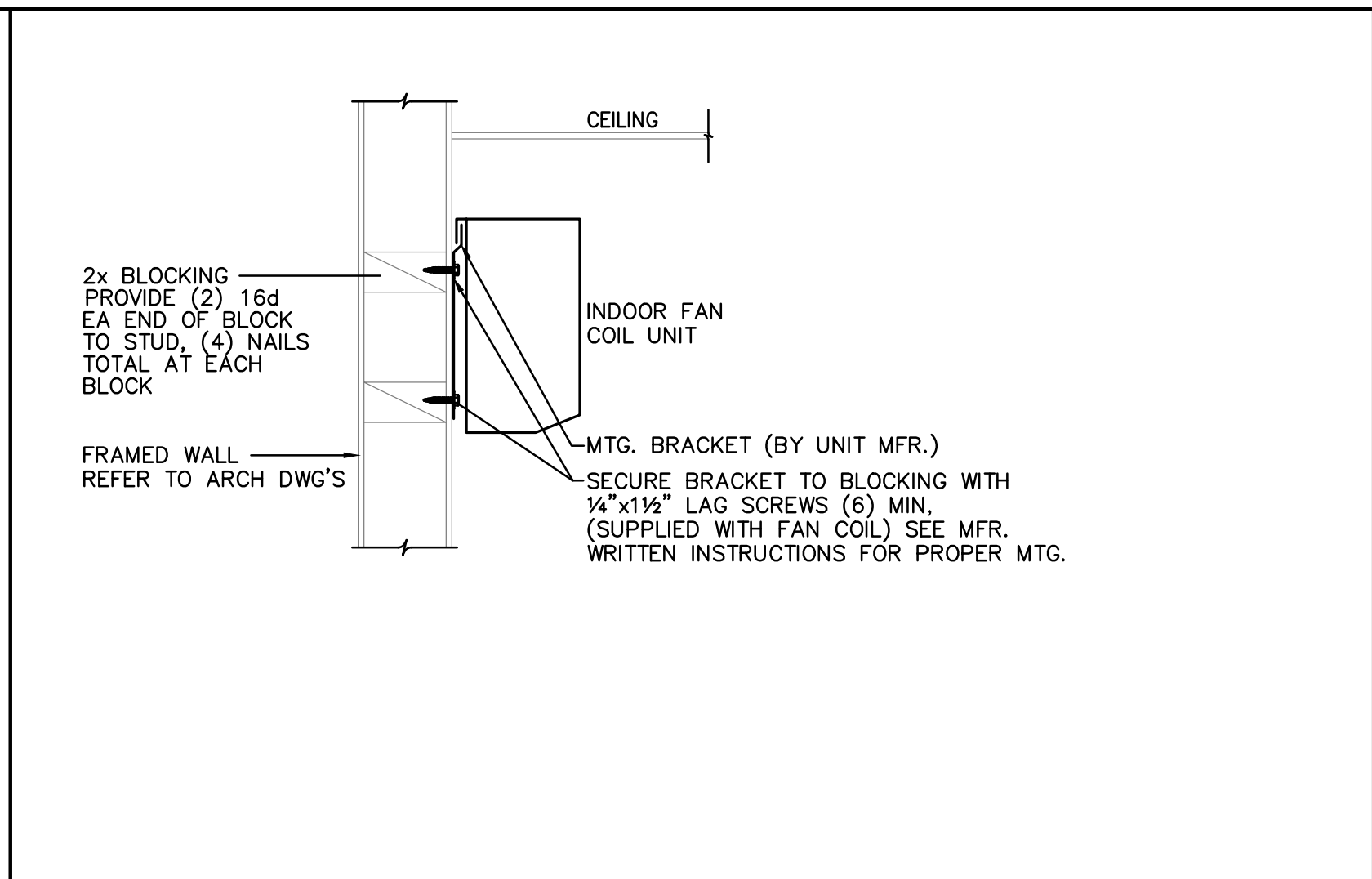
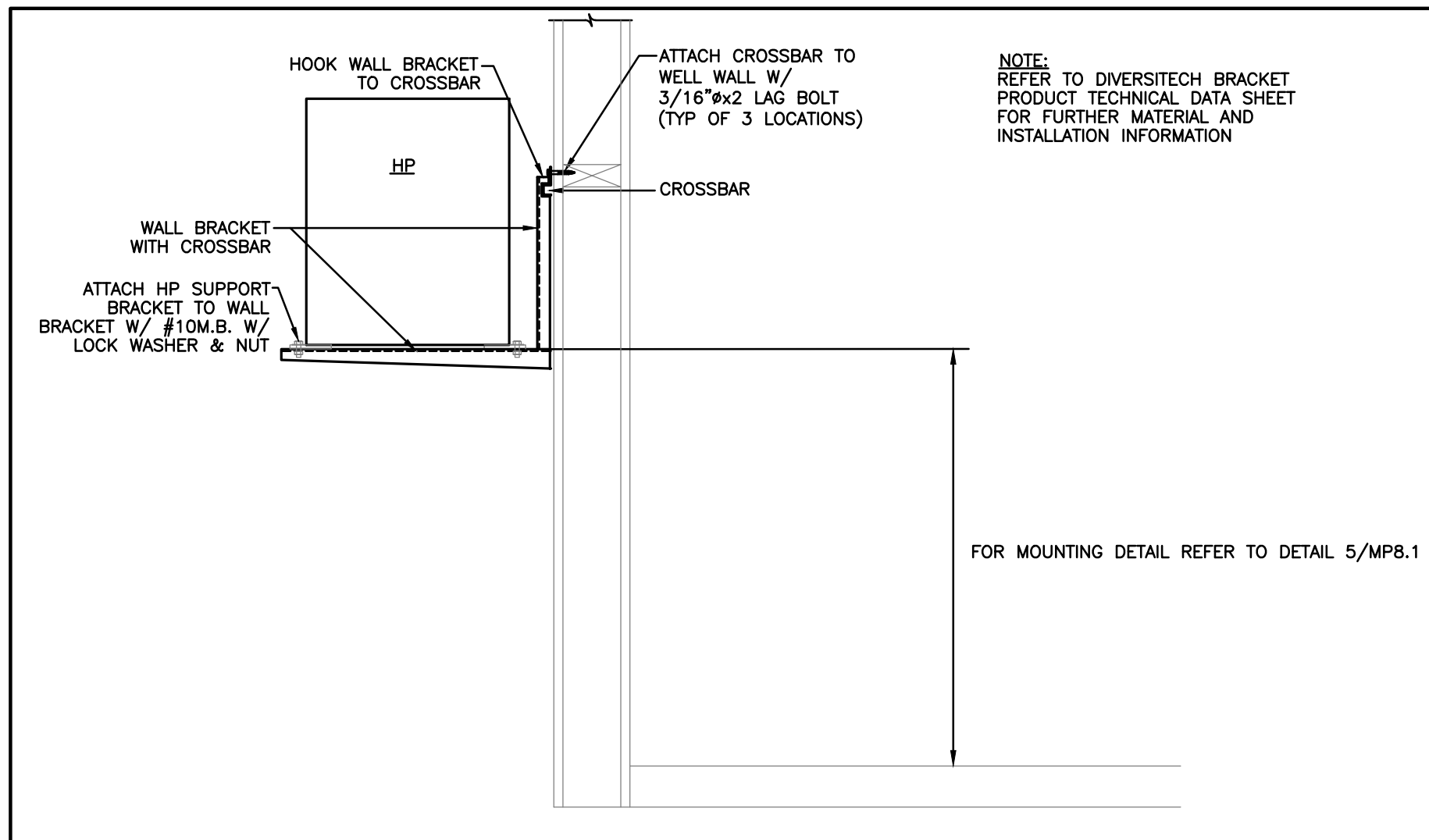

**2022 NON-RESIDENTIAL CALIFORNIA GREEN CODE NOTES**

**PERFORMANCE REQUIREMENTS:**

1. 5.201.1 SCOPE, CALIFORNIA ENERGY CODE, FOR THE PURPOSE OF MANDATORY ENERGY EFFICIENCY STANDARDS IN THIS CODE, THE CALIFORNIA ENERGY COMMISSION WILL CONTINUE TO ADOPT MANDATORY BUILDING STANDARDS.

**BUILDING MAINTENANCE AND OPERATION:**

5.410.4 TESTING AND ADJUSTING NEW BUILDINGS LESS THAN 10,000 SQUARE FEET. TESTING AND ADJUSTING OF SYSTEMS SHALL BE REQUIRED FOR NEW BUILDINGS LESS THAN 10,000 SQUARE FEET OR NEW SYSTEMS TO SERVE AN ADDITIONAL OR ALTERATION SUBJECT TO SECTION 303.1.

5.410.4.1 (RESERVED)

NOTE: FOR ENERGY-RELATED SYSTEMS UNDER THE SCOPE (SECTION 100) OF THE CALIFORNIA ENERGY CODE, INCLUDING HEATING, VENTILATION, AIR CONDITIONING (HVAC) SYSTEMS AND CONTROLS, INDOOR LIGHTING SYSTEM AND CONTROLS, AS WELL AS WATER HEATING SYSTEMS AND CONTROLS, REFER TO CALIFORNIA ENERGY CODE SECTION 120.8 FOR COMMISSIONING REQUIREMENTS AND SECTIONS 120.5, 120.6, 130.4, AND 140.9(S)3 FOR ADDITIONAL TESTING REQUIREMENTS OF SPECIFIC SYSTEMS.

5.410.4.2 SYSTEMS. DEVELOP A WRITTEN PLAN OF PROCEDURES FOR TESTING AND ADJUSTING SYSTEMS. SYSTEMS TO BE INCLUDED FOR TESTING AND ADJUSTING SHALL INCLUDE, AS APPLICABLE TO THE PROJECT:

- RENEWABLE ENERGY SYSTEMS
- LANDSCAPE IRRIGATION SYSTEMS.
- WATER REUSE SYSTEMS

5.410.4.3 PROCEDURES. PERFORM TESTING AND ADJUSTING PROCEDURES IN ACCORDANCE WITH MANUFACTURER'S SPECIFICATIONS AND APPLICABLE STANDARDS ON EACH SYSTEM.

5.410.4.3.1 HVAC BALANCING. IN ADDITION TO TESTING AND ADJUSTING, BEFORE A NEW SPACE-CONDITIONING SYSTEM SERVING A BUILDING OR SPACE IS OPERATED FOR NORMAL USE, BALANCE THE SYSTEM IN ACCORDANCE WITH THE PROCEDURES DEFINED BY THE TESTING ADJUSTING AND BALANCING BUREAU NATIONAL STANDARDS, THE NATIONAL ENVIRONMENTAL BALANCING BUREAU PROCEDURAL STANDARDS, ASSOCIATED AIR BALANCE COUNCIL NATIONAL STANDARDS OR AS APPROVED BY THE ENFORCING AGENCY.

5.410.4.4 REPORTING. AFTER COMPLETION OF TESTING, ADJUSTING AND BALANCING, PROVIDE A FINAL REPORT OF TESTING SIGNED BY THE INDIVIDUAL RESPONSIBLE FOR PERFORMING THESE SERVICES.

5.410.4.5 OPERATION AND MAINTENANCE (O & M) MANUAL. PROVIDE THE BUILDING OWNER OR REPRESENTATIVE WITH DETAILED OPERATING AND MAINTENANCE INSTRUCTIONS AND COPIES OF GUARANTEES/WARRANTIES FOR EACH SYSTEM. O & M INSTRUCTIONS SHALL BE CONSISTENT WITH OSHA REQUIREMENTS IN CCR, TITLE 8, SECTION 5142, AND OTHER RELATED REGULATIONS.

5.410.4.5.1 INSPECTIONS AND REPORTS. INCLUDE A COPY OF ALL INSPECTION VERIFICATIONS AND REPORTS REQUIRED BY THE ENFORCING AGENCY.

**POLLUTANT CONTROL:**

5.504.1 TEMPORARY VENTILATION. THE PERMANENT HVAC SYSTEM SHALL ONLY BE USED DURING CONSTRUCTION IF NECESSARY TO CONDITION THE BUILDING OR AREAS OR ADDITION OR ALTERATION WITHIN THE REQUIRED TEMPERATURE RANGE FOR MATERIAL AND EQUIPMENT INSTALLATION. IF THE HVAC SYSTEM IS USED DURING CONSTRUCTION, USE RETURN AIR FILTERS WITH A MINIMUM EFFICIENCY REPORTING VALUE (MERV) OF 8, BASED ON ASHRAE 52.2-1989, OR AN AVERAGE EFFICIENCY OF 30 PERCENT BASED ON ASHRAE 52.1-1992. REPLACE ALL FILTERS IMMEDIATELY PRIOR TO OCCUPANCY, OR, IF THE BUILDING IS OCCUPIED DURING ALTERATION, AT THE CONCLUSION OF CONSTRUCTION.

5.504.3 COVERING OF DUCT OPENINGS AND PROTECTION OF MECHANICAL EQUIPMENT DURING CONSTRUCTION. AT THE TIME OF ROUGH INSTALLATION AND DURING STORAGE ON THE CONSTRUCTION SITE UNTIL FINAL STARTUP OF THE HEATING, COOLING AND VENTILATION EQUIPMENT, ALL DUCT AND OTHER RELATED AIR DISTRIBUTION COMPONENT OPENINGS SHALL BE COVERED WITH TAPE, PLASTIC, SHEETMETAL OR OTHER METHODS ACCEPTABLE TO THE ENFORCING AGENCY TO REDUCE THE AMOUNT OF DUST, WATER AND DEBRIS WHICH MAY ENTER THE SYSTEM.

5.504.4 FINISH MATERIAL POLLUTANT CONTROL. FINISH MATERIALS SHALL COMPLY WITH SECTIONS 5.504.4.1 THROUGH 5.504.4.6.

5.504.4.1 ADHESIVES, SEALANTS AND CAULKS. ADHESIVES, SEALANTS, AND CAULKS USED ON THE PROJECT SHALL MEET THE REQUIREMENTS OF THE FOLLOWING STANDARDS:

- ADHESIVES, ADHESIVE BONDING PRIMERS, ADHESIVE PRIMERS, SEALANTS, SEALANT PRIMERS AND CAULKS SHALL COMPLY WITH LOCAL OR REGIONAL AIR POLLUTION CONTROL OR AIR QUALITY MANAGEMENT DISTRICT RULES WHERE APPLICABLE, OR SCAMD RULE 1168 VOC LIMITS, AS SHOWN IN SECTIONS 5.504.4.1 AND 5.504.4.2. SUCH PRODUCTS ALSO SHALL COMPLY WITH RULE 1168 PROHIBITION ON THE USE OF CERTAIN TOXIC COMPOUNDS (CHLOROFORM, ETHYLENE DICHLORIDE, METHYLENE CHLORIDE, PERCHLOROETHYLENE AND TRICHLOROETHYLENE), EXCEPT FOR AEROSOL PRODUCTS AS SPECIFIED IN SUBSECTION 2, BELOW.
- AEROSOL ADHESIVES, AND SMALLER UNIT SIZE OF ADHESIVES, AND SEALANT OR CAULKING COMPOUNDS (IN UNITS OF PRODUCT, LESS PACKAGING, WHICH DO NOT WEIGH MORE THAN ONE POUND AND DO NOT CONSIST OF MORE THAN 16 FLUID OUNCES) SHALL COMPLY WITH STATEWIDE VOC STANDARDS AND OTHER REQUIREMENTS, INCLUDING PROHIBITIONS ON USE OF CERTAIN TOXIC COMPOUNDS, OF CALIFORNIA CODE OF REGULATIONS, TITLE 17, COMMENCING WITH SECTION 94507.

5.504.4.2 HALONS. INSTALL HVAC, REFRIGERATION, AND FIRE SUPPRESSION EQUIPMENT THAT DO NOT CONTAIN HALONS.

5.504.4.3 PAINTS AND COATINGS. ARCHITECTURAL PAINTS AND COATINGS SHALL COMPLY WITH VOC LIMITS IN TABLE 1 OF THE ARB ARCHITECTURAL COATINGS SUGGESTED CONTROL MEASURE, AS SHOWN IN TABLE 5.504.4.3, UNLESS MORE STRINGENT LOCAL LIMITS APPLY. THE VOC CONTENT LIMIT FOR COATINGS THAT DO NOT MEET THE DEFINITIONS FOR THE QUALITY COATINGS CATEGORIES LISTED IN TABLE 5.504.4.3 SHALL BE DETERMINED BY CLASSIFYING THE COATINGS AS A FLAT, NONFLAT OR NONFLAT-HIGH GLOSS COATING, BASE ON ITS GLOSS, AS DEFINED IN SUBSECTIONS 4.2.1, 4.36 AND 4.37 OF THE 2007 CALIFORNIA AIR RESOURCES BOARD SUGGESTED CONTROL MEASURE, AND THE CORRESPONDING FLAT, NONFLAT OR NONFLAT-HIGH GLOSS VOC LIMIT IN TABLE 5.504.4.3 SHALL APPLY.

5.504.4.3.1 AEROSOL PAINTS AND COATINGS. AEROSOL PAINTS AND COATINGS SHALL MEET THE PWMV LIMITS FOR ROC N SECTION 94522(a)(3) AND OTHER REQUIREMENTS, INCLUDING PROHIBITIONS ON USE OF CERTAIN TOXIC COMPOUNDS AND OZONE DEPLETING SUBSTANCES, IN SECTIONS 94522(a)(2) AND (a)(3) OF CALIFORNIA CODE OF REGULATIONS, TITLE 17, COMMENCING WITH SECTION 94520, AND IN AREAS UNDER THE JURISDICTION OF THE BAY AREA AIR QUALITY MANAGEMENT DISTRICT ADDITIONALLY COMPLY WITH THE PERCENT VOC BY WEIGHT OF PRODUCT LIMITS OF REGULATION 8 RULE 49.

5.504.4.3.2 VERIFICATION. VERIFICATION OF COMPLIANCE WITH THIS SECTION SHALL BE PROVIDED AT THE REQUEST OF THE ENFORCING AGENCY. DOCUMENTATION MAY INCLUDE, BUT IS NOT LIMITED TO, THE FOLLOWING:

- MANUFACTURER'S PRODUCT SPECIFICATION
- FIELD VERIFICATION OF ON-SITE PRODUCT CONTAINERS

5.504.5.3 FILTERS. IN MECHANICALLY VENTILATED BUILDINGS, PROVIDE REGULARLY OCCUPIED AREAS OF THE BUILDING WITH AIR FILTRATION MEDIA FOR OUTSIDE AIR AND RETURN AIR THAT PROVIDES AT LEAST A MINIMUM EFFICIENCY REPORTING VALUE (MERV) OF 13. MERV 13 FILTERS SHALL BE INSTALLED PRIOR TO OCCUPANCY, AND RECOMMENDATIONS FOR MAINTENANCE WITH FILTERS OF THE SAME VALUE SHALL BE INCLUDED IN THE OPERATION AND MAINTENANCE MANUAL.

EXCEPTION: EXISTING MECHANICAL EQUIPMENT.

5.504.5.3.1 LABELING. INSTALLED FILTERS SHALL BE CLEARLY LABELED BY THE MANUFACTURER INDICATING THE MERV RATING.

5.504.7 ENVIRONMENTAL TOBACCO SMOKE (ETS) CONTROL. WHERE OUTDOOR AREAS ARE PROVIDED FOR SMOKING, PROHIBIT SMOKING WITHIN 25 FEET OF BUILDING ENTRIES, OUTDOOR AIR INTAKES AND OPERABLE WINDOWS AND WITHIN THE BUILDING AS ALREADY PROHIBITED BY OTHER LAWS OR REGULATIONS, OR AS ENFORCED BY ORDINANCES, REGULATIONS OR POLICIES OF ANY CITY, COUNTY, CITY AND COUNTY, CALIFORNIA COMMUNITY COLLEGE, CAMPUS OF THE CALIFORNIA STATE UNIVERSITY, OR CAMPUS OF THE UNIVERSITY OF CALIFORNIA, WHICHEVER ARE MORE STRINGENT. WHEN ORDINANCES, REGULATIONS OR POLICIES ARE NOT IN PLACE, POST SIGNAGE TO INFORM BUILDINGS OCCUPANTS OF THE PROHIBITIONS.

**INDOOR MOISTURE CONTROL:**

5.505.1 INDOOR MOISTURE CONTROL. BUILDINGS SHALL MEET OR EXCEED THE PROVISIONS OF CALIFORNIA BUILDING CODE, CCR TITLE 24, PART 2, SECTIONS 1202 SECTION 5.407.2 OF THIS CODE (VENTILATION) AND CHAPTER 14 (EXTERIOR WALLS). FOR ADDITIONAL MEASURES SEE CALIFORNIA BUILDING CODE, CCR TITLE 24, PART 2, SECTION 1201.1.

**INDOOR AIR QUALITY:**

5.506.1 OUTSIDE AIR DELIVERY. FOR MECHANICALLY OR NATURALLY VENTILATED SPACES IN BUILDINGS, MEET THE MINIMUM REQUIREMENTS OF SECTION 120.1.2 REQUIREMENTS FOR VENTILATION OF CALIFORNIA ENERGY CODE, OR THE APPLICABLE LOCAL CODE, WHICHEVER IS MORE STRINGENT AND DIVISION 1, CHAPTER 4 OF CCR, TITLE 8.

5.506.2 CARBON DIOXIDE (CO2) MONITORING. FOR BUILDINGS OR ADDITIONS EQUIPPED WITH DEMAND CONTROL VENTILATION, CO2 SENSORS AND VENTILATION CONTROLS SHALL BE SPECIFIED AND INSTALLED IN ACCORDANCE WITH THE REQUIREMENTS OF THE CALIFORNIA ENERGY CODE, SECTION 120.1(C)(4).

5.506.3 CARBON DIOXIDE (CO2) MONITORING IN CLASSROOMS. (DSA-SS) EACH PUBLIC K-12 SCHOOL CLASSROOM, AS LISTED IN TABLE 120.1-A OF THE CALIFORNIA ENERGY CODE, SHALL BE EQUIPPED WITH A CARBON DIOXIDE MONITOR OR SENSOR THAT MEETS THE FOLLOWING REQUIREMENTS:

- THE MONITOR OR SENSOR SHALL BE PERMANENTLY AFFIXED IN A TAMPER PROOF MANNER IN EACH CLASSROOM BETWEEN 3 AND 6 FEET (914mm AND 1829mm) ABOVE THE FLOOR AND AT LEAST 5 FEET (1524 mm) AWAY FROM DOORS AND OPERABLE WINDOWS.
- WHEN THE MONITOR OR SENSOR IS NOT INTEGRAL TO AN ENERGY MANAGEMENT CONTROL (EMCS), THE MONITOR OR SENSOR SHALL DISPLAY THE CARBON DIOXIDE READINGS ON THE DEVICE. WHEN THE SENSOR IS INTEGRAL TO AN EMCS, THE CARBON DIOXIDE READINGS SHALL BE AVAILABLE TO AND REGULARLY MONITORED BY FACILITY PERSONNEL.
- A MONITOR SHALL PROVIDE NOTIFICATION THROUGH A VISUAL INDICATOR ON THE MONITOR WHEN THE CARBON DIOXIDE LEVELS IN THE CLASSROOM HAVE EXCEEDED 1,100ppm.
- A MONITOR OR SENSOR SHALL MEASURE CARBON DIOXIDE LEVELS AT MINIMUM 15-MINUTE INTERVALS AND SHALL MAINTAIN A RECORD OF PREVIOUS CARBON DIOXIDE MEASUREMENTS OF NOT LESS THAN 30 DAYS DURATION.
- A MONITOR OR SENSOR USED TO MEASURE CARBON DIOXIDE LEVELS SHALL HAVE THE CAPACITY TO MEASURE CARBON DIOXIDE LEVELS WITH A RANGE OF 400ppm TO 2000ppm OR GREATER.
- THE MONITOR OR SENSOR SHALL BE CERTIFIED BY THE MANUFACTURER TO BE ACCURATE WITHIN 75ppm AND 1,000ppm CARBON DIOXIDE CONCENTRATION AND SHALL BE CERTIFIED BY THE MANUFACTURER TO REQUIRE CALIBRATION NO MORE FREQUENTLY THAN ONCE EVERY 5 YEARS.

**OUTDOOR AIR QUALITY:**

5.508.1 OZONE DEPLETION AND GREENHOUSE GAS REDUCTIONS. INSTALLATIONS OF HVAC, REFRIGERATION AND FIRE SUPPRESSION EQUIPMENT SHALL COMPLY WITH SECTIONS 5.508.1.1 AND 5.508.1.2.

5.508.1.1 CHLOROFLUOROCARBONS (CFCs). INSTALL HVAC, REFRIGERATION AND FIRE SUPPRESSION EQUIPMENT THAT DO NOT CONTAIN CFCs.

5.508.1.2 HALONS. INSTALL HVAC, REFRIGERATION, AND FIRE SUPPRESSION EQUIPMENT THAT DO NOT CONTAIN HALONS.

**SPLIT SYSTEM (HP/FAN COL) KEY NOTE SCHEDULE**

◇ PROVIDE WITH THE FOLLOWING ACCESSORIES:

- THERMOSTAT TO BE HARD WIRED
- REFRIGERANT CHARGE PER MANUFACTURERS WRITTEN INSTRUCTIONS.

**SPLIT SYSTEM (HP/FAN COL) REFRIGERANT PIPE KEY NOTE SCHEDULE**

① PROVIDE 3/4" (RES) PIPE INSULATION ON REFRIGERANT PIPE LINES PER 2022 BUILDING ENERGY EFFICIENCY STD.

**FUJITSU HEAT PUMP & FAN COIL SCHEDULE**

**18LMAS1 (ASUH18LMAS + AOUH18LMAS1) ◇①**

**FC-1 / HP-1**

SALES REP - JOHN DALEY  
PHONE - (510) 750-2552  
EMAIL - jrgroupie@gmail.com

MODEL NUMBERS		ASUH18LMAS
Indoor Unit		ADUH18LMAS1
Outdoor Unit		18LMAS1

EFFICIENCIES		21.1
SEER		21.1
SEER2		13
EER		13
EER2		12.5
HSPF		11.5/9.3
HSPF 2 (HV) / HSPF 2 (V)		4
CDP	kW/kWh	13.6
CDP2	Btu/kWh	13.6
CDP2	kW/kWh	13.6
CDP2	Btu/kWh	13.6

OUTDOOR TEMPERATURE OPERATION RANGE		14 to 115 (-10 to 46)
Cooling	'F (°C)	5 to 75 (-15 to 24)
Heating		

CAPACITIES		18000
Cooling	Rated	7,000-30,000
	Min.-Max.	21,600
Heating	Rated	8,000-29,000
	Min.-Max.	

LINESET REQUIREMENTS		Flare
Connection Method		
Liquid	in (mm)	Ø3/8 (Ø9.52)
Gas	in (mm)	Ø5/8 (Ø15.88)
Pre-charge length		49 (15)
Minimum Length	ft (m)	16(5)
Max. length		164 (50)
Max. height difference		98 (30)

INDOOR DIMENSIONS & WEIGHT		11 x 38-9/16 x 9-7/16 (280 x 980 x 240)
Net (H x W x D)	in (mm)	12-11/16 x 42-7/16 x 13-5/8 (322 x 1,078 x 346)
Net Weight	lb (kg)	29 (13.0)
Gross Weight		36 (16.5)

OUTDOOR DIMENSIONS & WEIGHT		31 x 37 x 12-5/8 (788 x 940 x 320)
Net (H x W x D)	in (mm)	38-1/16 x 40-7/16 x 17-1/2 (966 x 1,027 x 445)
Net Weight		117 (53)
Gross Weight	lb (kg)	134 (61)

FAN DATA		577 (980)
Indoor Unit Airflow rate	Cooling	489 (830)
	Heating	377 (640)
Outdoor Unit Airflow rate	Cooling	589 (1,000)
	Heating	500 (850)
Outdoor Unit Airflow rate	Cooling	377 (640)
	Heating	300 (510)

SOUND PRESSURE		46
Indoor Unit	Cooling	41
	Heating	35
Outdoor Unit	Cooling	30
	Heating	46
Outdoor Unit	Cooling	41
	Heating	35
Outdoor Unit	Cooling	49
	Heating	50

REFRIGERANT		R410A
Type		
Charge	lb oz	3 lb 15 oz
	g	1800
Oil Type		POE (R68)

ELECTRICAL SPECIFICATIONS		208/230 V - 60 Hz
Voltage/frequency/Phase		187-253 V
Available Voltage Range		6.2
Current	Cooling	7
	Heating	13.4
Maximum Operating Current	Cooling	13.9
	Heating	7
Starting Current		MCA = 17.1
MCA		20
Maximum Circuit Breaker		1.38
Input Power	Cooling	0.45-1.86
	Heating	1.58
Power Factor	Cooling	0.55-2.82
	Heating	96.8
		98.1

OTHER		4.0 (1.91)
Moisture Removal	pints/h (L/h)	Yes
Energy Star		PP-H10P1
Drain hose	Material	Ø17/32 (Ø13.8) (L.D.1)
	Tip diameter	Ø19/32 to 21/32 (Ø15.0 to 16.0)
Operation Range	Cooling	64 to 90 (18 to 32)
	Heating	80 or less
		86 (30) or less

1. WIRELESS REMOTE CONTROLLER WILL BE PROVIDED WITH UNIT  
2. SUPPLY THE WIRELESS REMOTE WITH REMOTE CONTROL TETHER SECURITY CABLE LEASH - CBL02  
3. PENETRATION TO THE OUTSIDE BE SEALED WITH SPRAY FOAM

**kuchman ARCHITECTS**

A Professional Corporation  
2203 13th Street  
Sacramento, CA 95818  
Tel: 916 447 3488  
Fax: 916 447 3488  
www.kuchman.com

1317 O STREET  
SACRAMENTO, CA 95814

MECHANICAL SCHEDULES & NOTES

DATE	NO.	MEMO	BY	APP.
APPROVED				MS
DRAWN				JJ
PROJECT NO.	23774			
DATE	OCTOBER 10, 2023			

**ALEXANDER SCHEFFLO and ASSOCIATES, Inc.**  
Mechanical Engineers (209) 948-9761  
2928 Pacific Ave. Stockton, CA. 95204

**MP8.1**

ALL DRAWINGS AND WRITTEN MATERIAL APPEARING HEREIN CONSTITUTE THE ORIGINAL AND UNPUBLISHED WORK OF THE ENGINEER AND THE SAME MAY NOT BE USED, REPRODUCED OR DISCLOSED WITHOUT THE WRITTEN CONSENT OF THE ENGINEER.  
© Alexander Schefflo & Assoc., Inc

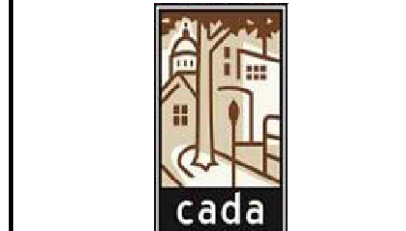
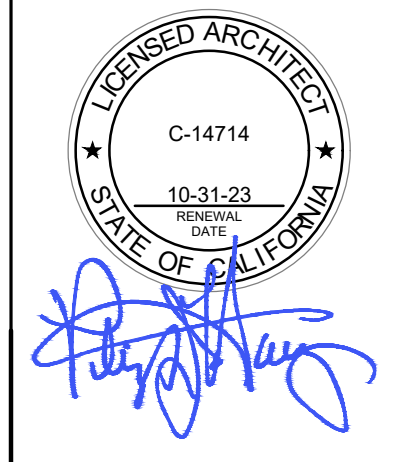

1317 O STREET  
SACRAMENTO, CA 95814

MECHANICAL SCHEDULES & NOTES

DATE	NO.	MEMO	BY	APP.
APPROVED				MS
DRAWN				JJ
PROJECT NO.	23774			
DATE	OCTOBER 10, 2023			

**ALEXANDER SCHEFFLO and ASSOCIATES, Inc.**  
Mechanical Engineers (209) 948-9761  
2928 Pacific Ave. Stockton, CA. 95204

**MP8.1**

ALL DRAWINGS AND WRITTEN MATERIAL APPEARING HEREIN CONSTITUTE THE ORIGINAL AND UNPUBLISHED WORK OF THE ENGINEER AND THE SAME MAY NOT BE USED, REPRODUCED OR DISCLOSED WITHOUT THE WRITTEN CONSENT OF THE ENGINEER.  
© Alexander Schefflo & Assoc., Inc

THIS DOCUMENT CONTAINS INFORMATION PROPRIETARY TO KUCHMAN ARCHITECTS PC AND IS UNLAWFUL TO BE REPRODUCED OR DISCLOSED TO OTHERS WITHOUT THE WRITTEN CONSENT OF KUCHMAN ARCHITECTS PC. ALL RIGHTS RESERVED. COPYRIGHT © 2023.



**EXHIBIT B**  
**TERMS AND CONDITIONS**  
**CONTRACT FOR PUBLIC WORKS: NEW CONSTRUCTION,**  
**REHABILITATION, REPAIR OR MAINTENANCE**

- 1. Contractor Relationship to CADA** - At all times during the term of this contract, Contractor shall be an independent contractor and shall not be an employee of Authority. Contractor shall have no authority, express or implied, to act as an agent of Authority in any capacity unless otherwise specifically provided herein.
- 2. Disclosure by Contractor** - Prior to execution of this Contract, Contractor shall disclose to Authority the names of any and all persons, partnerships, corporations and businesses which do business or are located within the Capitol Area (5th, 21st, L and R Streets) with whom contractor is affiliated or from whom Contractor receives income.
- 3. Termination** - If Contractor fails to perform the terms and conditions of this contract, Authority may terminate this contract and be relieved of payment to contractor. In the event of termination, Authority may proceed with the work in any manner deemed proper by Authority. The cost to the Authority shall be deducted from any sum due to Contractor under this contract, and the balance, if any, shall be utilized to offset any and all claims against Contractor.
- 4. Assignment** - Without the prior written consent of Authority, this contract is not assignable by Contractor, either in whole or in part, Authority may withhold consent to assign this contract its sole discretion.
- 5. Alteration in Contract** - No alteration or variation of the terms of this contract shall be valid unless made in writing and signed by the parties hereto, and no oral understanding or agreement not incorporated herein shall be binding on any of the parties hereto.
- 6. Consideration** - The consideration to be paid Contractor, as provided herein, shall be in compensation for all of Contractor's expenses incurred in the performance hereof, including travel and per diem unless otherwise expressly provided.
- 7. Indemnification** - Promptly upon execution of the Agreement, the Contractor specifically obligates itself and hereby agrees to protect, hold free and harmless, defend and indemnify the State of California, the City of Sacramento, and the Authority, and their respective officers, officials, agents, employees and volunteers from any and all liability, penalties, costs, losses, damages, expenses, causes of action, claims or judgments, including attorney's fees, which arise out of or are in any way connected with the Contractor's, or his subcontractors' or suppliers', performance of work under this Contract or failure to comply with any of the obligations contained in the Contract. This indemnity shall imply no reciprocal right of the Contractor in any action on the contract pursuant to California Civil Code section 1717 or section 1717.5. To the fullest extent legally permissible, this indemnity, defense and hold harmless agreement by the Contractor shall apply to any and all acts or omissions, whether active or passive, on the part of the Contractor or his agents, employees, representatives, or Subcontractor's agents, employees and representatives, resulting in claim or liability, irrespective of whether or not any acts or omissions of the parties to be indemnified hereunder may also have been a contributing factor to the liability, except such loss or damage which was caused by the active negligence, the sole negligence, or the willful misconduct of the State of California, the City of Sacramento, and the Authority, and/or their respective officers, officials, agents, employees and volunteers.

**8. Laws and Regulations** - Contractor shall observe and comply with all applicable Federal, State and local laws and regulations which in any way affect the conduct of work under this contract. Contractor shall, at its expense, obtain all permits, licenses, and insurance policies necessary for the completion of the contractor's obligations under this contract. All work to be performed under this contract is expressly subject to the requirements of the Building Code of the City of Sacramento, except that repair and rehabilitation work may be exempted from said requirements by the Executive Director. In the event of said exemption, the exempted contract work shall comply with all state construction standards as would be applicable to the State of California

**9. Executive Director** - The Executive Director shall be the representative of THE AUTHORITY for purposes of this Contract. He/She shall decide all questions as to the quality or acceptability of materials furnished and work performed, interpreting of the plans and specifications, and all questions as to the acceptable performance of the Contractor. The Executive Director may delegate some portion or all of his authority in this respect. Any reference to the Executive Director in this contract shall mean and refer to the Executive Director or his/her designee. Unless the context requires otherwise, references to Authority shall mean the Executive Director.

**10. Fair Employment Practices** - The Contractor shall comply with the provisions of the Fair Employment Addendum attached hereto and incorporated by reference into this contract. **To the extent not prohibited by law, the contractor shall enforce the provisions of THE AUTHORITY'S ESB Participation Program.**

**11. Changes in the Work to be Performed** - The Contractor shall make no change to the work, provide any extra or additional work, or supply labor, services, or materials beyond that actually required for the execution of the contract unless pursuant to a written order from the Executive Director authorizing the change. No claim for an adjustment of the contract price will be paid unless authorized by Authority by written change order.

**12. Notices** - Any and all notices, demands, requests or other matters required by this contract or by law to be served on, given to, or delivered to either party hereto, Authority or Contractor, by the other party to this contract, shall be in writing and shall be deemed duly served, given or delivered when personally delivered to the party to whom it is addressed or, in lieu of such personal service, when deposited in the United States mail, postage prepaid, addressed to the Authority or Contractor as provided in this contract. Either party may change his address for the purpose of notices by giving written notice of such change to the other party in the manner as herein provided.

**13. Substitution of Securities for Money Withheld** - At any time prior to final payment, Contractor may request substitution of securities for any money withheld by the Authority to ensure performance of the contract. At the expense of Contractor, securities equivalent to the money withheld may be deposited with Authority or with a bank as escrow agent according to a separate escrow agreement as provided in Public Contract Code Section 22300 or its successor. Securities eligible for substitution shall include those listed in Section 16430 of the Government Code or bank or savings and loan certificates of deposit. A fee set by the Authority shall be charged for such substitution.

**14. Method of Payment of Contract Price** - (a) No payment will be made for any work performed under this contract unless and until such work has been inspected by an authorized representative of Authority, and said inspector certifies that the work has been satisfactorily completed; (b) Any payment due Contractor will be paid as promptly as fiscal procedures permit after the Executive Director receives the Contractor's invoice and satisfactory evidence of release of all claims by all subcontractors and suppliers of material represented by Contractor's invoice. As a condition precedent to final payment, Contractor shall discharge the State of California, the City of Sacramento, Authority and the officers, agents, and employees of each, from all liabilities, obligations and claims arising under this contract; and (c) No payment made under the Contract shall act as a waiver of the right of the Authority to require the faithful performance of all terms of the Contract.

**15. Assignment of Antitrust Causes of Action** - In entering into a public works contract or a subcontract to supply goods, services, or materials pursuant to a public works contract, Contractor offers and agrees to assign to Capitol Area Development Authority all rights, title and interest in and to all causes of action it may have under Section 4 of the Clayton Act (15 U.S.C. Sec 15) or under the Cartwright Act (Chapter 2 commencing with Section 16700 of Part 2 of Division 7 of the California Business and Professions Code), arising from purchases of goods, services, or materials pursuant to the public works contract or the subcontract. This assignment shall be made and become effective at the time Authority tenders final payment to Contractor without further acknowledgment by the parties.

**16. Travel and Subsistence Payments** - Contractor shall pay travel and subsistence payments to each worker, employee or subcontractor needed to execute the work, as such travel and subsistence payments are defined in the applicable collective bargaining agreement filed in accordance with Section 1773.8 of the Labor Code.

**17. Payroll Records** - If this contract is for new construction, rehabilitation or repair, Contractor and each subcontractor shall comply with the requirements of Section 1770 of the Labor Code to maintain and produce certified payroll records.

**18. Payment of Prevailing Wages** – Prevailing wages are required to be paid on construction projects of \$25,001 or greater; or, repair, remodel or demolition projects that are \$15,001 or greater; or, projects that are funded by California State public works finance bonds or any other source that requires payment of prevailing wages. Prevailing wages are not required to be paid on construction projects less than or equal to \$25,000, or repair, remodel, or demolition projects less than or equal to \$15,000.

Copies of the prevailing rate of per diem wages are on file at the Authority's office and are available upon request or online at <http://www.dir.ca.gov/Public-Works/PublicWorks.html>. The Contractor shall forfeit as penalty to the Authority the amount specified by law for each calendar day or portion thereof for each worker (whether employed by the Contractor or any subcontractor) paid less than the stipulated prevailing rates for any work done under the Contract in violation of the provisions of the Labor Code and in particular, Section 1775.

The Authority will not recognize any claims for additional compensation because of the payment of the wages set forth in the Contract. The possibility of wage increases is one of the elements to be considered by the Contractor in determining its proposal, and will not under any circumstances, other than delays caused by the Authority, the Architect, or the Authority's agents, be considered as the basis of a claim against the Authority. The Authority shall review, including by way of job site inspections, and, if appropriate, audit payroll records to verify compliance with the public works requirements of the Labor Code.

If prevailing wages are required, Contractor agrees that the Project is subject to monitoring and enforcement of by the Division of Labor Standards Enforcement as set forth in Chapter 1 of Part 7 of Division 2 of the California Labor Code (commencing at section 1720) and the accompanying regulations at Subchapter 4.5 of Chapter 8 of Division 1 of Title 8 of the California Code of Regulations (commencing at section 16450). The Director of the Department of Industrial Relations of the State of California has determined the general prevailing rate of wages of per diem wages in the locality in which the Project is to be performed for each craft or type of worker needed to execute the Agreement. Copies of the applicable prevailing wage rate determinations are made available to the Contractor and subcontractor as of the date hereof. The Contractor shall post a copy of this document of the prevailing wages at each job site printed on 8 1/2" X 11" paper or larger, in accordance with California Code of Regulations, Title 8, section 16451(d). It shall be mandatory upon the Contractor and upon any subcontractor under the Contractor or her, to pay not less than the said specified prevailing rates of wages to all workers employed by them under the Agreement.

If prevailing wages are required, Contractor and subcontractors shall maintain and furnish to the Department of Industrial Relations, a certified copy of each weekly payroll (but no less often than monthly), with a statement of compliance signed under penalty of perjury. Such certified payroll reports in PDF form shall be transmitted electronically to the Department of Industrial Relations.

If prevailing wages are required, the Department of Industrial Relations shall review, including by way of job site inspections, and, if appropriate, audit payroll records to verify compliance with the public works requirements of the Labor Code. The Department of Industrial Relations will notify the Contractor or subcontractor(s), as appropriate) of any noncompliance, in order for all such Contractor or subcontractor(s) to correct the noncompliance. The Authority and Contractor shall cooperate with the Department of Industrial Relations and DLSE in any investigation of suspected violations of prevailing wage requirements.

The provisions of Labor Code section 1776 are incorporated herein by reference. As directed by the Labor Commissioner, the Authority shall withhold payments equal to the payments due or estimated to be due to the Contractor or subcontractors whose payroll records are delinquent or inadequate, plus any additional amount that the Labor Commissioner has reasonable cause to believe may be needed to cover a back wage and penalty assessment against such Contractor or subcontractors. The Contractor shall be required to withhold payments to a subcontractor whose payroll records are delinquent or inadequate until the Labor Commissioner provides notice that the subcontractor has cured such delinquency or deficiency.

**19. Contractor Registration** - No contractor or subcontractor may be listed on a bid proposal for a public works project subject to prevailing wage requirements unless registered with the Department of Industrial Relations pursuant to Labor Code section 1725.5. No contractor or subcontractor may be awarded a contract for public work on a public works project subject to prevailing wage requirements unless registered with the Department of Industrial Relations pursuant to Labor Code section 1725.5. All prevailing wage projects are subject to compliance monitoring and enforcement by the Department of Industrial Relations.

**20 Care and Protection** - Contractor shall be responsible for any damage done to property caused by nailing, moving materials to and/or from the work site, or any other cause attributable to work on this contract.

Notwithstanding the foregoing, in accordance with Government Code section 4215, the Contractor shall be compensated for the costs of locating, repairing damage not due to the failure of the Contractor to exercise reasonable care, and removing or relocating existing main or trunkline utility facilities which are not indicated in the contract plans and specifications with reasonable accuracy, and for the equipment on the project necessarily idled during such work, provided that the Contractor shall first notify the Authority before commencing work on locating, repairing damage to, removing or relocating such utilities. Contractor shall not be assessed liquidated damages for delays in completing the work when such delays are due to the failure of the Authority or the owner of the utility to provide for removal or relocation of such utility facilities.

The Contractor shall take all precautions necessary to protect the existing utilities within the project area. Any utilities damaged due to the Contractor's negligence shall be repaired or restored to their original condition at the Contractor's sole expense. Existing utilities shall be kept in service during the life of the Contract unless relocation, reconstruction, abandonment, or outage is specifically authorized by the Authority. The Contractor shall provide and maintain such temporary supports as may be necessary to preserve the functions of the various utility systems. No wires, conduits and/or pipes shall be removed until all services therein have been made inoperable.

The Contractor shall notify the Authority and appropriate Regional Notification Center for operators of subsurface installations at least two (2) working days, but not more than fourteen (14) calendar days, prior to performing excavation or other work close to any underground pipeline, conduit, duct, wire and other structures. The Contractor shall provide updated information to the Notification Center as required and on a periodic basis. The Regional Notification Center includes but is not limited to the Underground Service Alert-Northern California (USA) at 1-800-642-2444.

The Contractor is advised that the State of California does not participate in USA. The Contractor is required to notify CalTrans Permits Branch (916) 322-1297 for the location of State facilities.

The Contractor shall not proceed with work until utility facilities involved have been located, disconnected, or otherwise adjusted by utility representatives.

**21. Payment to Subcontractors** - Contractor shall submit to Authority prior to the commencement of work on the contract: (1) a list of the names and business addresses of each subcontractor, if any, who will perform work or labor or render service in any amount greater than one half of one percent of the total bid; (2) a description of the type of work to be done by each subcontractor; and (3) a statement of the portion of work to be done by each subcontractor. Unless the subcontractor is in default, Contractor shall pay his subcontractors within ten (10) days of receipt of each progress payment, unless otherwise agreed to in writing by the parties, the amount paid to Contractor for work performed by the subcontractors to the extent of each such subcontractor's interest therein.

**22. Stop Notices** - The Authority may, at its option, and at any time retain out of any money due Contractor, sums sufficient to cover any claims filed pursuant to Civil Code Section 3179, *et seq.*, or any similar statute.

**23. Working Hours** - No employee, workman, or subcontractor of the Contractor shall work in the excess of eight hours a day and forty hours in any one week unless compensation is paid for all excess hours at a rate not less than one and one-half times the prevailing wage as provided in Section 18 of these Standard Form Terms and Conditions. Contractor shall keep and shall require all subcontractors to keep an accurate record showing the name of and actual hours worked each calendar day and each calendar week by each worker employed under this contract which record shall be kept open at all reasonable hours to inspection by the Authority and by the Division of Labor Law Enforcement. The Contractor or subcontractor shall, as a penalty to the Authority, forfeit twenty-five dollars (\$25) for each worker employed in the execution of the contract by the Contractor, or its subcontractor, for each calendar day during which the worker is required or permitted to work more than 8 hours in any one calendar day and 40 hours in any one calendar week in violation of the provisions of either Labor Code Section 1813 or 1815.

**24. Apprentices** - Pursuant to Section 1777.5 and 1777.6 of the Labor Code and in accordance with the regulations of the California Apprenticeship Council (Title 8 California Code of Regulations Section 200, *et. seq.*) and local apprenticeship standards for the craft or trade, properly indentured apprentices may be employed in prosecution of work. Information relative to apprenticeship standards, wage schedules, and other requirements may be obtained from the Director of Industrial Relations, *ex officio*, the administrator of apprenticeship, State Building Annex 445 Golden Gate Avenue, San Francisco, or from the Division of Apprenticeship Standards and its branch offices.

**25. Accounting Records** - Contractor shall check all materials, equipment and labor entering into the work and shall keep such full and detailed accounts as may be necessary for proper financial management under this Contract. Authority shall be afforded access to all Contractor's records, books, correspondence, instructions, drafting, receipts, vouchers, memoranda and similar data relating to this contract, and Contractor shall preserve all such records for a period of three (3) years after the final payment.



**26. Contract Bonds** - At the time this contract is executed, Contractor shall provide the payment and performance bonds. The performance bond shall guarantee the faithful performance of the contract by the Contractor and shall be in the amount of one hundred percent (100%) of the contract price. The payment bond shall secure the payment of the claims of subcontractors, materialmen and employees, shall contain all other provisions required by law, and shall be in a sum equal to at 100% of the contract price as provided in Section 3248 of the Civil Code. Whenever the Executive Director has cause to believe that the surety has become insufficient, he may demand in writing of Contractor further bonds or additional surety.

**27. Surplus Materials and Clean-Up Premises** - Contractor shall keep the work site and the surrounding area clean and orderly during the course of the work. Surplus materials delivered to the job site and all materials, fixtures, and equipment shall remain or become the property of the Contractor and shall be removed from the job site promptly after completion. Surplus materials remaining on the work site for ten (10) days after completion of the Contract work shall be deemed the property of the Authority unless Authority demands that Contractor remove such materials. The Contractor shall leave the work site in a clean condition; any costs incurred by the Authority to clean the work site will be charged against Contractor.

**28. Excavations and Disposition of Hazardous Waste** - Any contract which involves digging trenches or other excavations that extend deeper than four (4) feet below the surface shall comply with the following:

A. The contractor shall promptly, and before the following conditions are disturbed, notify the Authority, in writing, of any: (1) Material that the contractor believes may be material that is hazardous waste, as defined in Section 25117 of the Health and Safety Code, that is required to be removed to a Class I, Class II, or Class III disposal site in accordance with provisions of existing law; (2) Subsurface or latent physical conditions at the site differing from those indicated; and (3) Unknown physical conditions at the site of any unusual nature, different materially from those ordinarily encountered and generally recognized as inherent in work of the character provided for in the contract.

B. The Authority shall promptly investigate the conditions indicated by Contractor's notice. If the Authority finds that the conditions do involve hazardous waste or do materially so differ and cause a decrease or increase in the Contractor's cost of, or the time required for, performance of any part of the work, the Authority shall issue a change order under the procedures set forth in this Contract.

C. In the event a dispute arises between the Authority and the Contractor whether the conditions involve hazardous waste or materially so differ, or cause a decrease or increase in the Contractor's cost of, or time required for, performance of any part of the work, the Contractor shall not be excused from the scheduled completion date(s) set forth in this Contract but shall diligently proceed with all work to be performed under this Contract. Contractor shall retain any and all rights provided by this Contract or by law pertaining to the resolution of disputes and protests between the parties hereto.

This clause is consistent with Public Contract Code Section 7104.

**29. Conditions with Air Pollution Control Actions** - Contractor shall comply with all air pollution control rules, regulations, ordinances, and statutes, which apply to any work performed pursuant to this Contract.

**30. Excusable Delays** - Contractor shall not be charged with liquidated damages for any delay in the completion of work due to: (a) Any act of the government, including but not limited to, controls or restrictions upon requisitioning of materials, equipment, tools, or labor by reason of war, national defense, or any other national emergency; (b) Causes not reasonably anticipated by the parties to this contract which are beyond the control and without the fault or negligence of the Contractor, including but not restricted to, acts of nature or the public enemy, fire, floods, epidemics, quarantine, restrictions, strikes, freight embargoes; and (c) Any delay of subcontractors occasioned by any of the causes specified in subparagraphs (a) and (b) above. If any delay occurs, Contractor shall promptly (in no event more than 10 calendar days) notify the Executive Director in writing of the cause of the delay. If notification occurs after ten (10) days, the delay may be excused only from the date of notification. If the facts show excusable delay, the Executive Director may extend the contract time by a period equal to the period of excusable delay only for the completion of the work as a whole.

**31. Guarantors** - Except as otherwise expressly provided in the Specifications and excepting only items or routine maintenance, ordinary wear and tear and unusual abuse or neglect, Contractor guarantees all work executed by Contractor and all supplies, materials, and devices of whatsoever nature incorporated in, or attached to the work, or otherwise delivered to Authority as a part of the work pursuant to the contract, to be absolutely free of all defects of workmanship and materials for a period of one year after final acceptance of the entire work by the Authority. In the event that Contractor shall fail to comply with the conditions of the foregoing guarantee within ten (10) days' time, after being notified of the defect in writing, Authority shall have the right, but shall not be obligated to, repair, or obtain the repair of, the defect and contractor shall pay to Authority on demand all costs and expenses of such repair. Notwithstanding anything herein to the contrary, in the event that any defect in workmanship or materials covered by the foregoing guarantee results in a condition which constitutes an immediate hazard to the health or safety of any person or any property interest, Authority shall have the right to immediately repair, or cause to be repaired, such defect and Contractor shall pay to Authority on demand all costs and expenses of such repair. The foregoing statement relating to hazards to health and safety and property shall be deemed to include either temporary or permanent repairs which may be required as determined in the sole discretion and judgment of Authority.

**32. Contractor Bankrupt** - If Contractor should commence any proceeding under the Bankruptcy Act, or if Contractor be adjudged a bankrupt, or if Contractor should make any assignment for the benefit of creditors, or if a receiver should be appointed on account of Contractor's insolvency, then the Authority may, without prejudice to any other right or remedy, declare Contractor to be in default and complete the work by giving notice to Contractor and his surety. Contractor's surety shall complete the work and in the event Contractor's surety fails to commence completion of the work within thirty (30) days of the date of notice of default, Authority shall have the right, but not the obligation, to complete or cause the completion of the work.

**33. Cooperation of Contractor** - After execution by Authority, Authority shall supply Contractor one complete copy of the contract documents. This set shall include plans, specifications, standard form terms and conditions, and the fully executed contract. Authority shall also make available to Contractor at least three (3) copies of plans and specifications for his use in prosecuting the work. One copy of plans and specifications shall be kept at the site of the work and be available for use by the Authority. Contractor may request additional copies of any of the contract documents and Authority shall supply such copies as requested at Contractor's cost. Contractor shall give the work the constant attention necessary to facilitate the progress thereof. Contractor shall cooperate with the Authority and with other contractors in every way possible. Authority shall allocate the work and designate the sequence of construction in the case of controversy between contractors. Contractor shall at all times have a competent superintendent at the site of the work and said superintendent shall be fully authorized as his agent on the work. Such superintendent shall be capable of reading and understanding the plans and specifications and shall receive and follow any instruction given by Authority.

**34. Drawings** - Before final acceptance of the work, Contractor shall provide to Authority as built construction drawings showing in detail all changes made from the original plans. Before final payment is made, Contractor shall furnish copies of all warranties, technical manuals, and maintenance manuals of instruction for all devices furnished or installed by Contractor.

**35. Trade Names** - For convenience in designation, certain articles or materials to be incorporated in the work may be designated under a trade name or the name of the manufacturer and his catalogue information. The use of an alternative article or material which is of equal quality and which has the required characteristics for the purpose intended will be permitted, subject to the following requirements: The burden of proof as to the quality and durability of alternatives shall be upon Contractor and he shall furnish all information necessary as required by the Executive Director. The Executive Director shall be the sole judge as to the quality and durability of alternative articles or materials and his decision shall be final. Whenever the specifications permit the substitution of similar or equivalent materials or articles, no tests or action relating to the approval of such substitute materials or articles will be made until the request for substitution is made in writing by Contractor accompanied by complete data as to the equality of the materials or articles proposed. Such request shall be made in ample time to permit approval without delaying the work, but need not be made in less than thirty-five (35) days after award of the contract.

**36. Patent Claims** - Contractor shall assume all costs arising from the use of patented materials, equipment, devices or processes used on or incorporated in the work and shall defend, indemnify and save harmless the Authority, State of California, City of Sacramento together with all their officers and employees, and their duly authorized representatives, from all actions of every nature for, or on account of the use of any patented materials, equipment, devices, or processes used on or incorporated in the work.

**37. Items Containing Trade Secrets or Proprietary Rights Prohibited** - Neither Contractor nor any subcontractor working for Contractor shall furnish any item or combination of items to which, or in which, Contractor or any such subcontractor shall fail or refuse to furnish with the scope of the contract and the contract price sufficient technical data or information in whatever form as may be required to enable Authority to contract with contractors other than Contractor and such subcontractor to maintain any such item or items in serviceable condition. "Contractors other than Contractor and such subcontractors" shall mean persons or business entities completely unrelated to Contractor or such subcontractor whether by ownership, business or familiar relationship, contract, license arrangement or any other arrangement of any nature. The foregoing prohibition shall include, without limitation of the generality of the foregoing, any item, assembly, or combination of items, process, or processes, electrical or mechanical or electro-mechanical or microprocessor process or program, or combination of sequence thereof. Neither Contractor nor any subcontractor shall furnish any item or combination of items pursuant to this contract containing any program or programmable item without first obtaining the written consent of the Executive Director which may be withheld or conditioned in any manner determined to be in the best interest of the Authority by the Executive Director in his sole discretion. In the event of any conflict between the provisions of this paragraph and paragraph 35 ("Trade Names"), the provisions of this paragraph shall prevail.

**38. Separate Contracts** - Authority reserves the right to let other contracts in connection with any project. Contractor shall afford other contractors reasonable opportunity for the introduction and storage of their materials and the execution of their work and shall properly connect and coordinate his work with theirs. If any part of Contractor's work depends on proper execution or results upon the work of any other contractor, Contractor shall inspect and promptly report to the Executive Director any defects in such work that renders it unsuitable for such proper execution and results. Contractor's failure so to inspect and report shall constitute an acceptance of the other contractor's work as fit and proper for the reception of contractor's work, except as to defects which may develop in the other Contractor's work after the execution of Contractor's work.

**39. Insurance** – During the term of this contract and until final completion and acceptance of the work required by contract documents, contractor shall maintain in full force and effect at his own expense the insurance coverage noted below. Certificate(s) of Insurance and required endorsements must be provided to the Authority before any work begins. Authority reserves the right to request or approve different limits than stated below. If Contractor fails to keep all the required insurance in force, Contractor shall immediately discontinue any and all work. Authority will withhold any and all payments, until notification is received by Authority that such insurance has been reissued in full force. Failure to maintain any items of required insurance will be sufficient cause for termination of the contract.

Insurance Companies must be acceptable to the Authority. Contractor shall maintain insurance on all of Contractor’s operations during the progress of the work, with insurance companies operating on an “admitted” basis in California with an AM BEST’s rating of at least A- VIII. Coverage shall be on forms acceptable to the Authority and shall be the greater of all the insurance coverages and limits carried by the contractor or the minimum insurance and amounts included below:

**A. Workers’ Compensation**

1. Statutory limits, as required by law.
2. Waiver of Right of Recovery Endorsement in favor of the Authority and any others, or equivalent endorsement, as required by Prime Contract.

**B. Commercial General Liability**

1. On an Occurrence Basis
  - (i) 1,000,000 Each Occurrence, Bodily Injury and Property Damage, combined single limit
  - (ii) 2,000,000 General Aggregate
  - (iii) 2,000,000 Products & Completed Operations Aggregate
  - (iv) 2,000,000 Personal & Advertising Liability Aggregate
  - (v) 2,000,000 Per Project Aggregate
2. CGL policy form shall be ISO CG 00 01 11 88, or equivalent, unless agreed to in writing by AUTHORITY.
3. Claims made policies, including modified occurrence forms, are not acceptable. Contractor’s deductible or self-insured retention shall be no greater than \$10,000 per occurrence.
4. CGL coverage to **include**:
  - (i) Premises operations and mobile equipment liability.
  - (ii) Completed operations and products liability.
  - (iii) Contractual liability insuring the obligations of Contractor’s obligations assumed in this contract.
  - (iv) Owner’s & Contractor’s Protective Liability (OCP).
  - (v) Coverage for explosion, collapse, and underground property damage.
  - (vi) Coverage for subsidence.
  - (vii) Broad form property damage.
  - (viii) Personal injury.
  - (ix) Severability of interest.

**C. Automobile**

1. \$1,000,000 Per Accident, Bodily Injury and Property Damage, combined single limit.
2. Liability shall be for “Any Auto.”
3. Coverage to include “Hired” and “Non-Owned” autos.

D. **Excess Liability**

1. On an Occurrence Basis. Claims made policies, including modified occurrence forms, are not acceptable.
2. 1,000,000 Each Occurrence, Bodily Injury and Property Damage, combined single limit.
3. 1,000,000 Aggregate.

E. **Builder's Risk**

1. Contractor is responsible for insurance on Contractor's work until final acceptance by Authority. Contractor can comply with this section through the purchase of an Installation Floater, or Builder's Risk insurance on an "All Risk" basis, excluding Earthquake & Flood.
2. Deductibles under the insurance required in 5.(a) shall be no larger than \$2,500 per occurrence.
3. Contractor shall be responsible for said deductible.
4. Authority shall be named as additional insured and loss payee on said policy.
5. Builder's Risk insurance shall allow for "testing."
6. Insurance in this section shall provide coverage for property stored off premises and while in transit.

F. **Additional Insureds**

1. **Policies described in item B, C, D, and E above, shall be endorsed to name Authority, 1322 O St Investors LP, Capitol Area Community Development Authority, the State of California, the City of Sacramento its subsidiaries and affiliates and their shareholders, directors, officers, employees and agents as additional insureds.**
2. Policies shall also add as an additional insured any other person or entity required by contract to be so added.
3. Policies shall stipulate that the insurance afforded to the additional insureds shall be primary insurance and that any insurance carried by the additional insureds shall be excess and non-contributory with Contractor's insurance.
4. **Contractor shall use Additional Insured Endorsement CG 20 38 04 13, and Primary and Non-Contributory Endorsement CG 20-01 or coverage at least as broad for policies described in B, C, D, and E above.**
5. Policies described in item B, C, and D above, shall include an insurer's waiver of subrogation rights in favor of the Authority.

G. **Certificates and Endorsements**

Certificates of insurance and all necessary endorsements shall be furnished by Contractor to Authority before any work is commenced hereunder by Contractor.

H. **Term of Coverage**

All such insurance coverage shall remain in effect until Contractor's work has been completed.

I. **Insurance Noncompliance by Contractor**

If Contractor does not comply with the insurance requirements of this contract, the Authority may, at its option, provide insurance coverage to protect the Authority and charge Contractor for the cost of that insurance. If the Authority elects to provide such insurance, this shall in no way limit or relieve Contractor of the duties and responsibilities assumed by it in this Contract.

**40. Claims and Disputes -**

**A. Definition**

A Claim is a demand or assertion by one of the parties seeking, as a matter of right, adjustment or interpretation of Contract terms, payment of money, extension of time, or other relief with respect to the terms of the Contract. The term "Claim" also includes other disputes and matters in question between the Authority and the Contractor arising out of or relating to the Contract Documents. Claims must be made by written notice; must include documents supporting delay claim, including but not limited to evidence of all facts supporting alleged claim and current schedule showing impact of event or occurrence on critical path. The responsibility to substantiate Claims shall rest with the party making the Claim. This contract does not recognize the term potential claim.

**B. Decision of Architect**

Claims, including those alleging an error or omission by the Architect (or if no Architect then Engineer) shall be referred initially to the Architect for action as provided in paragraph 41. A decision by the Architect, as provided in paragraph 41(d), shall be required as a condition precedent to mediation of a Claim between the Contractor and the Authority as to all such matters arising prior to the date final payment is due, regardless of whether such matters relate to execution and progress of the Work, or the extent to which the Work has been completed. The decision by the Architect in response to a Claim shall not be a condition precedent to mediation in the event: the position of Architect is vacant; the Architect has not received evidence or has failed to render a decision within agreed time limit; the Architect has failed to take action required under paragraph 41(d) within thirty (30) calendar days after the Claim is made, forty-five (45) calendar days have passed after the Claim has been referred to the Architect; or the Claim relates to a Stop Notice Claim.

**C. Time Limit on Claims**

Claims by either party must be made within ten (10) calendar days after occurrence of the event giving rise to such Claim or within ten (10) calendar days after the claimant first recognizes the condition giving rise to the Claim, whichever is later. Claims must be made by written notice. An additional Claim made after the initial Claim has been implemented by change order will not be considered. The failure of the Contractor to provide the required Notice shall constitute an express waiver of any right to assert such claim, whether affirmatively or defensively.

**D. Personal Certification of all Claims**

PERSONAL CERTIFICATION OF ALL CLAIMS, must be submitted with all claims in the following format on Contractor's letter head:

I, \_\_\_\_\_, BEING THE \_\_\_\_\_ (MUST BE AN OFFICER) OF \_\_\_\_\_ (GENERAL CONTRACTOR), DECLARE UNDER PENALTY OF PERJURY UNDER THE LAWS OF THE STATE OF CALIFORNIA AND DO PERSONALLY CERTIFY AND ATTEST THAT: I HAVE THOROUGHLY REVIEWED THE ATTACHED CLAIM FOR ADDITIONAL COMPENSATION AND/OR EXTENSION OF TIME, AND KNOW ITS CONTENTS, AND SAID CLAIM IS MADE IN GOOD FAITH; THE SUPPORTING DATA IS TRUTHFUL AND ACCURATE; THAT THE AMOUNT REQUESTED ACCURATELY REFLECTS THE CONTRACT ADJUSTMENT FOR WHICH THE CONTRACTOR BELIEVES THE AUTHORITY IS LIABLE; AND, FURTHER, THAT I AM FAMILIAR WITH CALIFORNIA PENAL CODE SECTION 72 AND CALIFORNIA GOVERNMENT CODE SECTION 12650-12655, ET SEQ, PERTAINING TO FALSE CLAIMS, AND FURTHER KNOW AND UNDERSTAND THAT SUBMISSION OR CERTIFICATION OF A FALSE CLAIM MAY LEAD TO FINES, IMPRISONMENT AND/OR OTHER SEVERE LEGAL CONSEQUENCES.

**E. Continuing Contract Performance**

Pending final resolution of a Claim including mediation, arbitration, or litigation, unless otherwise agreed to in writing, the Contractor shall proceed diligently with performance of the Contract, and the Authority shall continue to make any undisputed payments in accordance with the Contract. Contractor hereby waives, for itself and all Subcontractors, any and all rights of rescission or work stoppage based on Authority's failure to pay for disputed items included in or to be included in any Claim.

**F. Claims for Concealed or Unknown Conditions**

**1. Trenches or Excavations Less Than Four Feet Below the Surface.**

If conditions are encountered at the site which are subsurface or otherwise concealed physical conditions, which differ materially from those indicated in the Contract documents, or unknown physical conditions of an unusual nature, which differ materially from those ordinarily found to exist and generally recognized as inherent in construction activities of the character provided for in the Contract documents, then notice by the observing party shall be given to the other party promptly before conditions are disturbed and in no event later than twenty-one (21) calendar days after first observance of the conditions. The Architect will promptly investigate such conditions, and if they differ materially and cause an increase or decrease in the Contractor's cost of, time required for, or performance of any part of the Work, will recommend an equitable adjustment in the Contract sum, Contract time, or both. If the Architect determines that the conditions at the Site are not materially different from those indicated in the Contract documents and that no change in the terms of the Contract is justified, the Architect shall so notify the Authority and the Contractor in writing, stating the reasons. Claims by either party in opposition to such determination must be made within ten (10) calendar days after the Architect has given notice of the decision. If the Authority and the Contractor cannot agree on an adjustment in the Contract sum or the Contract time, the adjustment shall be referred to the Architect for initial determination, subject to other proceedings pursuant to paragraph 41.

**Trenches or Excavations Greater Than Four Feet Below the Surface.**

Pursuant to Public Contract Code §7104, when any excavation or trenching extends greater than four feet below the surface:

The Contractor shall promptly, and before the following conditions are disturbed, notify the District in writing, of any:

Material that the Contractor believes may be material that is hazardous waste, as defined in Section 25117 of the Health and Safety Code, that is required to be removed to a Class I, Class II, or Class III disposal site in accordance with the provisions of existing law.

Subsurface or latent physical conditions at the site differing from those indicated.

Unknown physical conditions at the site of any unusual nature, different materially from those ordinarily encountered and generally recognized as inherent in work of the character provided for in the Contract.

The Authority shall promptly investigate the conditions, and if it finds that the conditions do materially so differ, or do involve hazardous waste, and cause a decrease or increase in the Contractor's cost of, or the time required for, performance of any part of the work will issue a change order under the procedures described in the Contract.



In the event that a dispute arises between the Authority and the Contractor whether the conditions materially differ, or involve hazardous waste, or cause a decrease or increase in the Contractor's cost of, or time required for, performance of any part of the work, the Contractor shall not be excused from any scheduled completion date provided for by the Contract, but shall proceed with all work to be performed under the Contract. The Contractor shall retain any and all rights provided either by Contract or by law, which pertain to the resolution of disputes and protests between the contracting parties.

**G. Claims for Additional Cost**

If the Contractor wishes to make Claim for an increase in the Contract sum, written notice as provided herein shall be given before proceeding to execute the Work. Each Claim for additional cost must include any claim for additional time associated with that claim and include all associated for both time and cost in their entirety. Prior notice is not required for claims relating to an emergency endangering life or property. If the Contractor believes additional cost is involved for reasons, including, but not limited to the following: a written interpretation from the Architect, an order by the Authority to stop the Work where the Contractor was not at fault, a written order for a minor change in the Work issued by the Architect, failure of payment by the Authority, termination of the Contract by the Authority, the Authority's suspension of the Work, or other reasonable grounds, a claim shall be filed in accordance with the procedure established herein.

**H. Claims for Additional Time**

**1. Notice and Extent of Claim**

If the Contractor wishes to make a claim for an increase in the Contract time, written notice as provided herein shall be given. The Contractor's claim shall include the cost associated with the extension and effect of delay on progress of the Work. In the case of a continuing delay, only one (1) claim is necessary. Any claim for time must include a fragmentary schedule as described in 39(h)(1)(a).

**a. FRAGMENTARY SCHEDULE FOR EXTENSION OF TIME.**

(i) The Contractor's fragmentary schedule shall show all additional schedule activities required by a delay and all changes to existing schedule activities made necessary by the delay. For each additional or changed activity, contractor shall identify the new duration, start and finish dates and predecessor-successor relationships.

(ii) Authority reserves the right to modify the fragmentary schedule to more accurately reflect the effect of changed work.

(iii) Failure to submit a fragmentary schedule will result in waiving contractor's right for additional time.

(iv) Failure to request a time extension in accordance with 40(c) will result in waiving Contractor's right for additional time.

**2. Adverse Weather Claims.**

If adverse weather conditions are the basis for a claim for additional time, such claim shall be documented by data substantiating that weather conditions were abnormal for the period of time, could not have been reasonably anticipated, and had an adverse effect on the Project Critical path.

3. No Reservation Allowed.

In no event will the Contractor be allowed to reserve its rights to assert a claim for time extension later than as required by paragraph 39(c) unless the Authority agrees in writing to allow such reservation.

a. Injury or Damage to Person or Property.

If either party to the Contract suffers injury or damage to person or property because of an act or omission of the other party, any of the other party's employees or agents, or others for whose acts such party is legally liable, written notice of such injury or damage, whether or not insured, shall be given to the other party within a reasonable time not exceeding twenty-one (21) days after first observance. The notice shall provide sufficient detail to enable the other party to investigate the matter. If a claim for additional cost or time related to this claim is to be asserted, it shall be made as provided in paragraphs 40(g) or 40(h).

**41. Resolution of Claims and Disputes -**

**A. Architect's Review.**

The Architect will review claims and take one or more of the following preliminary actions within ten (10) days of receipt of a claim: request additional supporting data from the claimant; submit a schedule to the parties indicating when the Architect expects to take action; reject the claim in whole or in part, stating reasons for rejection; recommend approval of the claim by the other party; or suggest a compromise. The Architect may also, but is not obligated to, notify the surety, if any, of the nature and amount of the claim.

**B. Documentation if Resolved**

If a claim has been resolved, the Architect will prepare or obtain appropriate documentation.

**C. Actions if Not Resolved**

If a claim has not been resolved, the party making the claim shall, within ten (10) days after the Architect's preliminary response, take one or more of the following actions: submit additional supporting data requested by the Architect; modify the initial claim; or notify the Architect that the initial claim stands.

**D. Architect's Written Decision**

If a claim has not been resolved after consideration of the foregoing and of other evidence presented by the parties or requested by the Architect, the Architect will notify the parties in writing that the Architect's decision will be made within seven (7) days. Upon expiration of such time period, the Architect will render to the parties its written decision relative to the claim, including any change in the Contract sum or Contract time or both. The Architect may, but is not obligated to, notify the surety and request the surety's assistance in resolving the controversy.

**42. Submission of Claim to Authority**

(a) Authority Review of Unresolved Claims

To the extent that the Contractor disputes the Architect's Written Decision issued pursuant to paragraph 41(D), or to the extent the Architect fails to issue a timely written decision, the Contractor may file a written claim, as defined by Public Contract Code section 9204(c)(1), with the Authority including reasonable documentation to support the claim. Upon receipt of the claim, the Authority shall conduct a reasonable review of the claim, and within a period not to exceed 45 days, the Authority shall provide the Contractor with a written statement identifying what portion of the claim is disputed and what portion is undisputed. The time in which the Authority must provide a written statement may be extended by mutual agreement of the parties as specified by Public Contract Code section 9204(d)(1)(C). The Authority shall pay any undisputed portion of the claim within 60 days after issuance of its written statement.

(b) Meet and Confer Regarding Unresolved Claims

If the Contractor disputes the Authority's written statement issued pursuant to Paragraph 41(D) or if the Authority fails to issue a timely written response, the Contractor may demand in writing an informal conference to meet and confer for settlement of the issues in dispute. Upon receipt of a demand in writing sent by registered mail or certified mail, return receipt requested, the Authority shall schedule a meet and confer conference within 30 days for settlement of the dispute. The meet and confer conference shall be attended by senior executives of the parties who have authority to settle the controversy. Within 10 business days following the conclusion of the meet and confer conference, the Authority shall provide the Contractor with a written statement identifying the portion of the claim that remains in dispute and the portion that is undisputed. The Authority shall pay any undisputed portion of the claim within 60 days after it issues its written statement.

(c) Mediation

If the Contractor disputes, in writing, any portion of the Authority's written statement as issued under Paragraph 41(D), the disputed items shall be submitted to nonbinding mediation according to the provisions of Public Contract Code section 9204(d)(2), and any costs of mediation shall be allocated as set forth in that section. Upon receipt of a claim, the Authority and the Contractor may agree to waive, in writing, mediation.

(d) Failure to Respond or Pay

If the Authority fails to timely respond to a claim from the Contractor or otherwise fails to meet the time requirements of Public Contract Code section 9204, the claim shall be deemed rejected in its entirety. Additionally, amounts not timely paid in the manner required by Public Contract Code section 9204 shall bear interest at 7 percent per annum.

(e) Subcontractor Claims

If a subcontractor or a lower tier subcontractor lacks legal standing to assert a claim against the Authority because privity of contract does not exist, the Contractor may present to the Authority a claim on behalf of the subcontractor or lower tier subcontractor pursuant to Public Contract Code section 9204(d)(5).

**44. Attorney's Fees** - In the event any action is brought by either party to this contract to enforce this contract or for breach of this contract or for a declaration of rights and duties of the parties to this contract, the prevailing party shall recover its cost of suit and attorney's fees incurred in such action from the other party.

**45. Conflict** – In the event of a conflict or inconsistency between the Specifications (General or Technical), the Drawings, and/or the Scope of Work portion of the contract documents, the documents shall govern in the following order of precedence: the Specifications, the Drawings, and the Scope of Work. Technical Specifications take precedence over general Specifications and detail Drawings take precedence over general Drawings. As between schedules and other information given on Drawings, the schedules shall govern. If an item is shown on any Drawing and not specifically included in the Specifications, the Drawing shall govern. Such conflict or inconsistency shall be brought to the attention of the Executive Director as soon as the conflict is discovered.

**46. Fair Employment Addendum -**

The Authority adopts this Fair Employment Addendum as its M/WBE contracting policy. It shall be included in all contracts and be applicable as provided herein.

**A. Nondiscrimination and Enforcement**

The provisions of the Part A of the Fair Employment Addendum shall apply to all contracts.

1. In the performance of this contract the Contractor will not discriminate against any employee or applicant for employment because of race, religious creed, color, national origin, ancestry, physical disability, mental disability, mental condition, marital status, or sex pursuant to Section 12940 *et seq.*, of the Government Code. The Contractor will ensure that applicants are employed, and that employees are treated during employment without regard to their race, religious creed, color, national origin, ancestry, physical disability, mental condition, marital status, or sex. Such action shall include, but not be limited to, the following: employment, upgrading, demotion or transfer; recruitment or recruitment advertising; layoff or termination; rates of pay or other forms of compensation; terms, conditions or privileges of employment; and selection for training, including apprenticeship. The Contractor shall post in conspicuous places, available to employees and applicants for employment, notices to be provided by Authority setting forth the provisions of this Fair Employment Addendum section.

2. Contractor will permit access to his records of employment, employment advertisements, application forms, and other pertinent data and records by the Fair Employment and Housing Commission or Authority for the purpose of investigation to ascertain compliance with the Fair Employment section of this Agreement.

3. Contractor shall designate an individual responsible for the enforcement of this Fair Employment Addendum, and shall provide the name, address and telephone number of such person to the Authority.

4. Remedies for willful violation:

(a) Authority may determine a willful violation of these Fair Employment provisions to have occurred upon receipt of a final judgment having that effect from a court in an action to which Contractor was a party, or upon receipt of a written notice from the Fair Employment and Housing Commission that it has investigated and determined that Contractor has violated the California Fair Employment and Housing Act and has issued an order, under Government Code Section 12970, which has become final, or obtained injunctive relief under Government Code Section 129704.

(b) For willful violation of these Fair Employment provisions, Authority shall have the right to terminate this contract either in whole or in part, and any loss or damage sustained by Authority in securing the goods or services hereunder shall be borne and paid by Contractor and by its surety under the performance bond, if any. Authority may deduct from any monies due, or that thereafter may become due to Contractor, the differences between the price named in the Contract and the actual cost thereof to Authority.



# HVAC UPGRADE PROJECT 1317 O STREET SACRAMENTO, CALIFORNIA 95814

## Section 3

### Other Required Documents

**Contractor, upon AWARD OF CONTRACT, MUST be prepared to complete and/or provide all the documents listed in this section.**

- Payment Bond (100%)
- Performance Bond (100%)
- Workers Compensation Insurance Certification
- Warranty / Guarantee
- Any Change Orders or Contract Modifications (if issued)
- Unconditional Waiver and Release Upon Progress Payment
- Unconditional Waiver and Release Upon Final Payment
- Certificates of Insurance *as required by Exhibit B Terms and Conditions*
- Required Licenses (Copies of All Licenses)
- Apprentice Statement
- Form W-9; Request for Taxpayer I.D. Certification
- CADA Contractor Code of Conduct
- Asbestos-Free Materials Certification
- Recycled Content Certification (Pub. Cont. Code § 22152)

**CAPITOL AREA DEVELOPMENT AUTHORITY  
PAYMENT BOND  
100%**

**KNOW ALL PERSONS BY THESE PRESENTS:**

WHEREAS, the CAPITOL AREA DEVELOPMENT AUTHORITY, hereinafter "CADA," has awarded to \_\_\_\_\_ hereinafter designated as the "Principal," a contract for:

**HVAC UPGRADE PROJECT  
Sacramento, CA 95814**

WHEREAS, said Principal is required to furnish a bond in connection with said contract, to secure payment of claims of laborers, mechanics, or materialmen employed to work under said contract, as provided by law:

NOW, THEREFORE, we the undersigned Principal and Surety are held and firmly bound unto CADA in the sum of: \_\_\_\_\_ Dollars (\$ \_\_\_\_\_), for which payment well and truly to be made, we bind ourselves, our heirs, executors, administrators, successors, or assigns jointly and severally, firmly by these presents.

**THE CONDITIONS OF THIS OBLIGATION** are such that if said Principal, his or its heirs, executors, administrators, successors, or assigns or subcontractors shall fail to pay for any material or provisions, provender or other supplies or teams, implements or machinery used in, upon, for or about the performance of the work contracted to be done, or for any work or labor thereon of any kind, or for amounts due under the Unemployment Insurance Act with respect to such work or labor, as required by the provisions of Chapter 7, Title XV, Part 4, Division 3 of the Civil Code (commencing with Section 3247) and provided that the claimant shall have complied with the provisions of said code; or for any amounts required to be deducted, withheld, and paid over to the Franchise Tax Board from the wages of employees of the contractor and his subcontractors pursuant to Section 18806 of the Revenue and Taxation Code, with respect to such work and labor, the Surety or Sureties hereon will pay for the same and in the amount not exceeding the sum specified in this bond, otherwise the above obligation shall be void. In case suit is brought upon this bond, Surety will pay a reasonable attorney's fee to be fixed by the court.

This bond shall insure to the benefit of any and all persons, companies and corporations entitled to file claims under Section 3181 of the Civil Code of the State of California so as to give a right of action to them or their assigns in any suit brought upon this bond.

Said Surety, for value received, hereby stipulates and agrees that in accordance with the contract documents, no change, extension of time, alteration or addition to the terms of the contract, or to the work to be performed thereunder, or to the specifications accompanying the same, shall in any way affect its obligations on this bond, and it does hereby waive notice of any such change, extension of time, alteration or addition to the terms of the contract documents or to the work.

**IN WITNESS WHEREOF**, the above bounden parties have executed this instrument

under their seals this \_\_\_\_ day of \_\_\_\_\_, 2023, the name of each corporate party being affixed thereto, and these presents duly signed by its undersigned representatives, pursuant to authority of its governing body.

Principal: \_\_\_\_\_

By: \_\_\_\_\_

Surety: \_\_\_\_\_

By: \_\_\_\_\_

APPROVED AS TO FORM:

By:  
Legal Counsel

**CAPITOL AREA DEVELOPMENT AUTHORITY  
PERFORMANCE BOND  
100%**

**KNOW ALL PERSONS BY THESE PRESENTS:**

WHEREAS, the CAPITOL AREA DEVELOPMENT AUTHORITY (hereinafter "CADA") has awarded to \_\_\_\_\_, hereinafter designated as the "Principal," a contract for:

**HVAC UPGRADE PROJECT  
1317 O Street  
Sacramento, CA 95814**

WHEREAS, said Principal is required under the terms of said contract to furnish a bond for the faithful performance of said contract.

NOW, THEREFORE, we the Principal, and \_\_\_\_\_ as Surety, are held and firmly bound unto CADA in the penal sum of: \_\_\_\_\_ **Dollars** (\$\_\_\_\_\_), lawful money of the United States for the payment of which sum well and truly to be made, we bind ourselves, our heirs, executors, administrators, successors, or assigns jointly and severally firmly by these presents.

**THE CONDITION OF THIS OBLIGATION** is such that if the above bounden Principal, his or its heirs, executors, administrators, successors or assigns, shall in all things stand to and abide by, and well and truly keep and perform the covenants, conditions and agreement in the said contract and any alteration thereof made as therein provided, on his or their part, to be kept and performed at the time and in the manner therein specified and all respects according to their true intent and meaning; and shall indemnify and save harmless CADA, its officers and agents as therein stipulated, then this obligation shall become null and void; otherwise it shall be and remain in full force and virtue.

And the Surety, for value received hereby stipulates and agrees that, in accordance with the contract documents, no change, extension of time, alteration or addition to the terms of the contract or to the work to be performed thereunder shall in any way affect its obligation on this bond, and it does hereby waive notice of any such change, extension of time, alteration or additions to the terms of the contract documents.

**IN WITNESS WHEREOF**, the above bounden parties have executed this instrument on this \_\_\_\_ day of \_\_\_\_\_, 2023.

Principal:

By:

Surety:

By:

APPROVED AS TO FORM:

By: \_\_\_\_\_  
Legal Counsel





## CAPITOL AREA DEVELOPMENT AUTHORITY WORKERS' COMPENSATION INSURANCE CERTIFICATION

### WORKERS' COMPENSATION DECLARATION

WARNING: FAILURE TO SECURE WORKERS' COMPENSATION COVERAGE IS UNLAWFUL, AND SHALL SUBJECT AN EMPLOYER TO CRIMINAL PENALTIES AND CIVIL FINES UP TO ONE HUNDRED THOUSAND DOLLARS (\$100,000), IN ADDITION TO THE COST OF COMPENSATION, DAMAGES AS PROVIDED FOR IN SECTION 3706 OF THE LABOR CODE, INTEREST, AND ATTORNEY'S FEES.

**I hereby affirm under penalty of perjury ONE of the following declarations:**

\_\_\_\_\_ I have and will maintain a certificate of consent to self-insure for workers' compensation, issued by the Director of Industrial Relations as provided for by Section 3700 of the Labor Code, for the performance of the work for which this permit is issued.

**OSIP Certificate No.** \_\_\_\_\_

\_\_\_\_\_ I have and will maintain workers' compensation insurance, as required by Section 3700 of the Labor Code, for the performance of the work for which this permit is issued. My workers' compensation insurance carrier and policy number are:

**Carrier** \_\_\_\_\_ **Policy Number** \_\_\_\_\_ **Expiration Date** \_\_\_\_\_

**Name of Agent** \_\_\_\_\_ **Phone #** \_\_\_\_\_

\_\_\_\_\_ I certify that, in the performance of the work for which this permit is issued, I shall not employ any person in any manner so as to become subject to the workers' compensation laws of California, and agree that, if I should become subject to the workers' compensation provisions of Section 3700 of the Labor Code, I shall forthwith comply with those provisions.

\_\_\_\_\_  
Signature of Applicant

\_\_\_\_\_  
Date

---

### **PLEASE READ CAREFULLY BEFORE SIGNING**

To be signed by authorized corporate officer or partner or individual submitting the bid. If the bidder is: (example)

1. An individual using a firm name, sign:  
"John Doe, an individual doing business as Blank Company."
2. An individual doing business under his own name, sign:  
"Your name only."
3. A co-partnership, sign: "John Doe and Richard Doe, co-partners doing business as Blank Company, by John Doe, Co-Partner."
4. A corporation: "Blank Company, by John Doe, Secretary" (or other title)

Contract # C24-\_\_\_\_

**CAPITOL AREA DEVELOPMENT AUTHORITY  
WARRANTY / GUARANTEE**

We hereby unconditionally guarantee the materials and workmanship for:

**HVAC UPGRADE PROJECT  
1317 O Street  
Sacramento, CA 95814**

in which we propose to furnish and perform in the Capitol Area for **Two (2) Years** in accordance with the contract between us and the Capitol Area Development Authority (CADA). We agree to repair or replace any or all such materials and work ("work"), together with all or any other work which may be damaged or displaced in so doing, that may prove to be not in accordance with the requirements of the contract or defective in workmanship or material within the period of two (2) years from the date of acceptance without expense whatsoever to CADA, ordinary wear and tear and unusual abuse or neglect excepted.

In the event of our failure to commence said repair or replacement work pursuant to the above-mentioned conditions within five (5) days after being notified in writing of any work not in accordance with the requirements of the contract or any defect in the work, or to prosecute with due diligence all work necessary to fulfill the terms of this guarantee and to complete the work within a reasonable period of time, we collectively and separately do hereby authorize CADA to proceed to have the defects repaired and made good at our expense and will pay the costs and damages therefore immediately upon demand. CADA shall be entitled to all costs, including reasonable attorney's fees, necessarily incurred by our refusal to pay the above costs.

Notwithstanding the foregoing paragraph, in the event of an emergency constituting an immediate hazard to the health or safety of CADA's employees, property, licensees, or the public, CADA may undertake at our expense without prior notice all work necessary to correct such hazardous condition when it was caused by our tract or other defect in the work.

Dated: \_\_\_\_\_, 2023

Signed: \_\_\_\_\_



## Application for Progress Payment

From: Company Name	Date:	
Address	Project:	HVAC Upgrade Project
City, State Zip	Contract #:	C24-
Phone #: 555-555-5555		

Payment Request #: \_\_\_\_\_ Period Covered: \_\_\_\_\_

<b>Application for Progress Payment</b>			CADA Approvals	
			Acctg	Director
1.	Original Contract Amount	\$		
2.	Authorized Change Orders - # _____ through _____.	\$		
3.	Current Adjusted Contract Amount (Line 1 + 2)	\$		
<b>Work Completed to Date - Current Amount Due</b>				
4.	Percent of Work Completed to Date _____% (% times line 1)	\$		
5.	Percent of Work Change Order Work Completed _____% (% times line 2)	\$		
6.	Total Value of Work Completed (\$ Line 4 + Line 5)	\$		
7.	Less Retention (5%) (5% times Line 6)	\$		
8.	Net Amount Earned to Date (Line 6 – Line 7)	\$		
9.	Paid to Date (Line ___ of Last Invoice)	\$		
10.	Balance due this pay period	\$		
<b>Contract Balance Information</b>				
12.	Balance on Contract (excluding retention) (Line 3 minus 5% minus Line 9)			
13.	Total Amount Remaining (Line 3 – Line 9)			

**Certificate for Payment**

In accordance with the contract documents, based on on-site observations and the data comprising this application, I certify to the best of my knowledge, information and belief that the work is completed and the quality of the work is in accordance with the contract documents, and that the contractor is entitled to the payment.

PROJECT ARCHITECT

By: \_\_\_\_\_ Date \_\_\_\_\_

CADA PROJECT REPRESENTATIVE

By: \_\_\_\_\_ Date \_\_\_\_\_

**Contractor's Statement**

The undersigned contractor certifies that to the best of his knowledge, information & belief; the work covered by this Application for Payment has been completed in accordance with the contract documents. Contractor further certifies that the current amount applied for and the percentage of work complete is an accurate representation of actual work done.

CONTRACTOR

By: \_\_\_\_\_ Date \_\_\_\_\_

Print Name/Title: \_\_\_\_\_

**BE SURE TO COMPLETE SIDE 2 OF THIS APPLICATION**

**CONDITIONAL WAIVER AND RELEASE ON PROGRESS PAYMENT (Civil Code Section 8132)**

NOTICE: THIS DOCUMENT WAIVES THE CLAIMANT'S LIEN, STOP PAYMENT NOTICE, AND PAYMENT BOND RIGHTS EFFECTIVE ON RECEIPT OF PAYMENT. A PERSON SHOULD NOT RELY ON THIS DOCUMENT UNLESS SATISFIED THAT THE CLAIMANT HAS RECEIVED PAYMENT.

**Identifying Information**

Name of Claimant: Company Name Name of Customer: CADA  
 Job Location: 1317 O Street Owner: CADA  
 Through Date: \_\_\_\_\_

**Conditional Waiver and Release**

This document waives and releases lien, stop payment notice, and payment bond rights the claimant has for labor and service provided, and equipment and material delivered, to the customer on this job through the Through Date of this document. Rights based upon labor or service provided, or equipment or material delivered, pursuant to a written change order that has been fully executed by the parties prior to the date that this document is signed by the claimant, are waived and released by this document, unless listed as an Exception below. This document is effective only on the claimant's receipt of payment from the financial institution on which the following check is drawn:

Maker of Check: CADA Amount of Check: \_\_\_\_\_  
 Check Payable to: Company Name

**Exceptions**

This document does not affect any of the following: (1) Retentions. (2) Extras for which the claimant has not received payment. (3) The following progress payments for which the claimant has previously given a conditional waiver and release but has not received payment: Date(s) of waiver and release: \_\_\_\_\_  
 Amount(s) of unpaid progress payment(s): \$\_\_\_\_\_. (4) Contract rights, including (A) a right based on rescission, abandonment, or breach of contract, and (B) the right to recover compensation for work not compensated by the payment.

**Signature**

Claimant's Signature: \_\_\_\_\_  
 Claimant's Title: \_\_\_\_\_  
 Date of Signature: \_\_\_\_\_

**Previous payment – unconditional status** - Previous Payment:  Yes  No  
 Unconditional Waiver on Progress Release Received for Previous Payment:  Yes  No

	<u>Change Order Amount</u>	<u>% Complete</u>	<u>Due this Pay App</u>	<u>Verified - Director</u>
Change Order #1	\$ _____	_____	\$ _____	<input type="checkbox"/>
Change Order #2	\$ _____	_____	\$ _____	<input type="checkbox"/>
Change Order #3	\$ _____	_____	\$ _____	<input type="checkbox"/>
Change Order #4	\$ _____	_____	\$ _____	<input type="checkbox"/>
Change Order #5	\$ _____	_____	\$ _____	<input type="checkbox"/>
Change Order #6	\$ _____	_____	\$ _____	<input type="checkbox"/>
Change Order #7	\$ _____	_____	\$ _____	<input type="checkbox"/>
Change Order #8	\$ _____	_____	\$ _____	<input type="checkbox"/>
Change Order #9	\$ _____	_____	\$ _____	<input type="checkbox"/>
<b>Total Change Order Amount Due through this Application:</b>			\$ _____	

**For Reference Only - Pending change Orders**  
**Note: These change orders in no way affect this payment application**

Change Order #	\$ _____
Change Order #	\$ _____
Change Order #	\$ _____



## Application for Retention Payment

From: Company Name	Date:	
Address	Project:	HVAC Upgrade Project
City, State Zip	Contract #:	C24-
Phone #: 555-555-5555		

Payment Request #: \_\_\_\_\_ Period Covered: \_\_\_\_\_

<b>Application for Retention Payment</b>			CADA Approvals	
			Acctg	Director
1.	Original Contract Amount	\$		
2.	Authorized Change Orders - # _____ through _____.	\$		
3.	Current Adjusted Contract Amount (Line 1 + 2)	\$		
<b>Work Completed to Date - Current Amount Due</b>				
4.	Percent of Work Completed to Date: <u>100 %</u> (Line 3) Current Amount Due on Contract 100%	\$		
5.	Paid to Date (Line ___ of Last Invoice)	\$		
10.	Balance due this pay period	\$		

**Certificate for Payment**

In accordance with the contract documents, based on on-site observations and the data comprising this application, I certify to the best of my knowledge, information and belief that the work is completed and the quality of the work is in accordance with the contract documents, and that the contractor is entitled to the payment.

PROJECT ARCHITECT

By: \_\_\_\_\_  
Date

CADA PROJECT REPRESENTATIVE

By: \_\_\_\_\_  
Date

**Contractor's Statement**

The undersigned contractor certifies that to the best of his knowledge, information & belief; the work covered by this Application for Payment has been completed in accordance with the contract documents. Contractor further certifies that the current amount applied for and the percentage of work complete is an accurate representation of actual work done.

CONTRACTOR

By: \_\_\_\_\_  
Date

Print Name/Title: \_\_\_\_\_

**BE SURE TO COMPLETE SIDE 2 OF THIS APPLICATION**

**CONDITIONAL WAIVER AND RELEASE ON FINAL PAYMENT (Civil Code Section 8136)**

NOTICE: THIS DOCUMENT WAIVES THE CLAIMANT'S LIEN, STOP PAYMENT NOTICE, AND PAYMENT BOND RIGHTS EFFECTIVE ON RECEIPT OF PAYMENT. A PERSON SHOULD NOT RELY ON THIS DOCUMENT UNLESS SATISFIED THAT THE CLAIMANT HAS RECEIVED PAYMENT.

**Identifying Information**

Name of Claimant: Company Name Name of Customer: CADA  
Job Location: 1317 O Street Owner: CADA  
Through Date: \_\_\_\_\_

**Conditional Waiver and Release**

This document waives and releases lien, stop payment notice, and payment bond rights the claimant has for labor and service provided, and equipment and material delivered, to the customer on this job. Rights based upon labor or service provided, or equipment or material delivered, pursuant to a written change order that has been fully executed by the parties prior to the date that this document is signed by the claimant, are waived and released by this document, unless listed as an Exception below. This document is effective only on the claimant's receipt of payment from the financial institution on which the following check is drawn:

Maker of Check: CADA Amount of Check: \_\_\_\_\_  
Check Payable to: Company Name

**Exceptions**

This document does not affect any of the following: Disputed claims for extras in the amount of: \_\_\_\_\_

**Signature**

Claimant's Signature: \_\_\_\_\_  
Claimant's Title: \_\_\_\_\_  
Date of Signature: \_\_\_\_\_

**Previous payment – unconditional status** - Previous Payment:  Yes  No

Unconditional Waiver on Progress Release Received for Previous Payment:  Yes  No

**Change Order Amount - 100 % Complete**

Change Order #1        \$ \_\_\_\_\_  
Change Order #2        \$ \_\_\_\_\_  
Change Order #3        \$ \_\_\_\_\_  
Change Order #4        \$ \_\_\_\_\_  
Change Order #5        \$ \_\_\_\_\_  
Change Order #6        \$ \_\_\_\_\_  
Change Order #7        \$ \_\_\_\_\_  
Change Order #8        \$ \_\_\_\_\_  
Change Order #9        \$ \_\_\_\_\_

**Total Change Order for Project:**        \$ \_\_\_\_\_



## Contractor Insurance Requirements

Contractor shall maintain insurance on all of Contractor's operations during the progress of the work, with insurance companies operating on an "admitted" basis in California with an AM BEST's rating of at least A- VIII. Coverage shall be on forms acceptable to CADA and shall be the greater of all insurance coverages and limits carried by the contractor or the minimum insurance and amounts included below:

### 1. Workers' Compensation

- a. Statutory limits, as required by law.
- b. Employers liability
  - i. \$1,000,000 by accident
  - ii. \$1,000,000 by disease - policy limit
  - iii. \$1,000,000 by disease - each employee
- c. **Waiver of Right of Recovery (Waiver of Subrogation) Endorsement in favor of CADA, Owner, and any others, as required by Contract.**

### 2. Commercial General Liability

- a. On an Occurrence Basis
  - i. 1,000,000 Each Occurrence, Bodily Injury and Property Damage, combined single limit
  - ii. 2,000,000 General Aggregate
  - iii. 2,000,000 Products & Completed Operations Aggregate
  - iv. 2,000,000 Personal & Advertising Liability Aggregate
  - v. 2,000,000 Per Project Aggregate
- b. CGL policy form shall be ISO CG 00 01 11 88, or equivalent, unless agreed to in writing by CADA.
- c. Claims made policies, including modified occurrence forms, are not acceptable.
- d. Contractor's deductible or self-insured retention shall be no greater than 10,000 per occurrence.
- e. CGL coverage to **include**:
  - i. Premises operations and mobile equipment liability.
  - ii. Completed operations and products liability.
  - iii. Contractual liability insuring the obligations of Contractor's obligations assumed in this contract.
  - iv. Owner's & Contractor's Protective Liability (OCP).
  - v. Coverage for explosion, collapse, and underground property damage.
  - vi. Coverage for subsidence.
  - vii. Broad form property damage.
  - viii. Personal injury.
  - ix. Severability of interest.

### 3. Automobile

- a. \$1,000,000 Per Accident, Bodily Injury and Property Damage, combined single limit.
- b. Liability shall be for "Any Auto"
- c. Coverage to include "Hired" and "Non-Owned" autos

### 4. Excess Liability

- a. On an Occurrence Basis
- d. Claims made policies, including modified occurrence forms, are not acceptable.
- b. 1,000,000 Each Occurrence, Bodily Injury and Property Damage, combined single limit
- c. 1,000,000 Aggregate

## Contractor Insurance Requirements

### 5. Builder's Risk

- a. Contractor is responsible for insurance on Contractor's work until final acceptance by CADA. Contractor can comply with this section through the purchase of an Installation Floater, or Builder's Risk insurance on an "All Risk" basis, excluding Earthquake & Flood.
- b. Deductibles under the insurance required in 5.(a) shall be no larger than 2,500 per occurrence.
- c. Contractor shall be responsible for said deductible.
- d. CADA shall be named as additional insured and loss payee on said policy.
- e. Builder's Risk insurance shall allow for "testing".
- f. Insurance in this section shall provide coverage for property stored off premises and while in transit.

### 6. Additional Insureds

**POLICIES DESCRIBED IN ITEM 2, 3, 4, AND 5 ABOVE, SHALL BE ENDORSED TO NAME CADA, 1322 O ST INVESTORS LP, CAPITOL AREA COMMUNITY DEVELOPMENT CORPORATION, STATE OF CALIFORNIA, CITY OF SACRAMENTO, ITS SUBSIDIARIES AND AFFILIATES AND THEIR SHAREHOLDERS, DIRECTORS, OFFICERS, EMPLOYEES AND AGENTS AS ADDITIONAL INSUREDS.**

- a. Policies shall also add as an additional insured any other person or entity required by contract to be so added.
- b. Policies shall stipulate that the insurance afforded to the additional insureds shall be **primary** insurance and that any insurance carried by the additional insureds shall be excess and non-contributory with Contractor's insurance.
- c. **Contractor shall use Additional Insured Endorsement CG 20 38 04 13 and Primary and Non-Contributory Endorsement CG 20 01, or coverage equally as broad for policies described in 2, 4, and 5 above.**

### 7. Certificates

Certificates of insurance shall be furnished by Contractor to CADA before any work is commenced hereunder by Contractor.

- d. The certificates shall provide that there will be no cancellation, reduction, or modification of coverage without 30 days' prior written notice to CADA.
- e. The words "**endeavor to**" shall be stricken from the certificate.
- f. The words "**But failure to mail such notice shall impose no obligation or liability of any kind upon the company, its agents or representatives**" shall be stricken from the certificate.

### 8. Term of Coverage

All such insurance coverage shall remain in effect until Contractor's work has been completed and received final acceptance by CADA.

### 9. Insurance Noncompliance By Contractor

If Contractor does not comply with the insurance requirements of this contract, CADA may, at its option, provide insurance coverage to protect Owner and CADA and charge Contractor for the cost of that insurance. If CADA elects to provide such insurance, this shall in no way limit or relieve Contractor of the duties and responsibilities assumed by it in this Subcontract.

**All construction contracts require Bonds as noted below —**

- Payment Bond 100%
- Performance Bond 100%





## **CAPITOL AREA DEVELOPMENT AUTHORITY TRAINING OF APPRENTICES ON PUBLIC WORKS CONTRACTS**

Attention is directed to the provisions in Section 1777.5 (Chapter 1411, Statutes of 1968) and 1777.6 of the Labor Code concerning the employment of apprentices by the contractor or any subcontractor under him.

Section 1777.5, as amended, requires the contractor or subcontractor employing tradesmen in any apprentice occupation to apply to the joint apprenticeship committee nearest the site of the public works project and which administers the apprenticeship program in that trade for a certificate of approval. The certificate will also fix the ratio of apprentices to journeymen that will be used in the performance of the contract. The ratio of apprentices to journeymen in such cases shall not be less than one to five except where an exception is issued on one of the following conditions:

- A. In the event unemployment for the previous three-month period in such area exceeds an average of fifteen percent (15%), or
- B. In the event the number of apprentices in training in such area exceeds a ratio of 1 to 5, or
- C. If there is a showing that the apprentice craft or trade is replacing at least one-thirtieth (1/30) of its journeymen annually through apprenticeship training, either (1) on a statewide basis, or (2) on a local basis.
- D. If assignment of an apprentice to any work performed under a public works contract would create a condition which would jeopardize his life or the life, safety, or property of fellow employees or the public at large or if the specific task to which the apprentice is to be assigned is of such a nature that training cannot be provided by a journeyman.

The contractor is required to make contributions to funds established for the administration of apprenticeship programs if he employs registered apprentices or journeymen in any apprentice trade on such contracts and if other contractors on the public works site are making such contributions.

The contractor and any subcontractor under him shall comply with the requirement of Sections 1777.5 and 1777.6 in the employment of apprentices. Noncompliance with Section 1777.5 can result in substantial penalties under Section 1777.7.

Information relative to apprenticeship standards, wage schedules, and other requirements may be obtained from the Director of Industrial Relations, ex officio the Administrator of Apprenticeship, San Francisco, California, or from the Division of Apprenticeship Standards and its branch offices.

# Request for Taxpayer Identification Number and Certification

Give Form to the requester. Do not send to the IRS.

▶ Go to [www.irs.gov/FormW9](http://www.irs.gov/FormW9) for instructions and the latest information.

Print or type. See Specific Instructions on page 3.	1 Name (as shown on your income tax return). Name is required on this line; do not leave this line blank.		
	2 Business name/disregarded entity name, if different from above		
	3 Check appropriate box for federal tax classification of the person whose name is entered on line 1. Check only <b>one</b> of the following seven boxes.		4 Exemptions (codes apply only to certain entities, not individuals; see instructions on page 3):  Exempt payee code (if any) _____  Exemption from FATCA reporting code (if any) _____  <i>(Applies to accounts maintained outside the U.S.)</i>
	<input type="checkbox"/> Individual/sole proprietor or single-member LLC <input type="checkbox"/> C Corporation <input type="checkbox"/> S Corporation <input type="checkbox"/> Partnership <input type="checkbox"/> Trust/estate		
	<input type="checkbox"/> Limited liability company. Enter the tax classification (C=C corporation, S=S corporation, P=Partnership) ▶ _____ <b>Note:</b> Check the appropriate box in the line above for the tax classification of the single-member owner. Do not check LLC if the LLC is classified as a single-member LLC that is disregarded from the owner unless the owner of the LLC is another LLC that is <b>not</b> disregarded from the owner for U.S. federal tax purposes. Otherwise, a single-member LLC that is disregarded from the owner should check the appropriate box for the tax classification of its owner.		
	<input type="checkbox"/> Other (see instructions) ▶ _____		
	5 Address (number, street, and apt. or suite no.) See instructions.		Requester's name and address (optional)
6 City, state, and ZIP code			
7 List account number(s) here (optional)			

## Part I Taxpayer Identification Number (TIN)

Enter your TIN in the appropriate box. The TIN provided must match the name given on line 1 to avoid backup withholding. For individuals, this is generally your social security number (SSN). However, for a resident alien, sole proprietor, or disregarded entity, see the instructions for Part I, later. For other entities, it is your employer identification number (EIN). If you do not have a number, see *How to get a TIN*, later.

**Note:** If the account is in more than one name, see the instructions for line 1. Also see *What Name and Number To Give the Requester* for guidelines on whose number to enter.

<b>Social security number</b>										
				-			-			
<b>or</b>										
<b>Employer identification number</b>										
				-						

## Part II Certification

Under penalties of perjury, I certify that:

- The number shown on this form is my correct taxpayer identification number (or I am waiting for a number to be issued to me); and
- I am not subject to backup withholding because: (a) I am exempt from backup withholding, or (b) I have not been notified by the Internal Revenue Service (IRS) that I am subject to backup withholding as a result of a failure to report all interest or dividends, or (c) the IRS has notified me that I am no longer subject to backup withholding; and
- I am a U.S. citizen or other U.S. person (defined below); and
- The FATCA code(s) entered on this form (if any) indicating that I am exempt from FATCA reporting is correct.

**Certification instructions.** You must cross out item 2 above if you have been notified by the IRS that you are currently subject to backup withholding because you have failed to report all interest and dividends on your tax return. For real estate transactions, item 2 does not apply. For mortgage interest paid, acquisition or abandonment of secured property, cancellation of debt, contributions to an individual retirement arrangement (IRA), and generally, payments other than interest and dividends, you are not required to sign the certification, but you must provide your correct TIN. See the instructions for Part II, later.

<b>Sign Here</b>	Signature of U.S. person ▶	Date ▶
------------------	----------------------------	--------

## General Instructions

Section references are to the Internal Revenue Code unless otherwise noted.

**Future developments.** For the latest information about developments related to Form W-9 and its instructions, such as legislation enacted after they were published, go to [www.irs.gov/FormW9](http://www.irs.gov/FormW9).

## Purpose of Form

An individual or entity (Form W-9 requester) who is required to file an information return with the IRS must obtain your correct taxpayer identification number (TIN) which may be your social security number (SSN), individual taxpayer identification number (ITIN), adoption taxpayer identification number (ATIN), or employer identification number (EIN), to report on an information return the amount paid to you, or other amount reportable on an information return. Examples of information returns include, but are not limited to, the following.

- Form 1099-INT (interest earned or paid)

- Form 1099-DIV (dividends, including those from stocks or mutual funds)
- Form 1099-MISC (various types of income, prizes, awards, or gross proceeds)
- Form 1099-B (stock or mutual fund sales and certain other transactions by brokers)
- Form 1099-S (proceeds from real estate transactions)
- Form 1099-K (merchant card and third party network transactions)
- Form 1098 (home mortgage interest), 1098-E (student loan interest), 1098-T (tuition)
- Form 1099-C (canceled debt)
- Form 1099-A (acquisition or abandonment of secured property)

Use Form W-9 only if you are a U.S. person (including a resident alien), to provide your correct TIN.

*If you do not return Form W-9 to the requester with a TIN, you might be subject to backup withholding. See What is backup withholding, later.*



## CADA Contractor/Vendor Code of Conduct

If any Subcontractor, Contractor, and/or their respective employees fails or refuses to carry out the directions of CADA Project Manager/Facilities Manager or appears to CADA Project Manager/Facilities Manager to be incompetent or to act in an improper manner, that person shall be removed from the Project immediately on any reasonable request of the CADA Project Manager/Facilities Manager. That person shall not again be employed on the Work. Such discharge shall not be the basis for any claim for compensation or damages against CADA, or any of its officers or agents.

While performing the Work at a CADA property, the Contractor, the Subcontractor, and/or their respective employees shall:

1. wear an identification badge, t-shirt, letter of authority or other identification showing the affiliation with the contractor or subcontractor;
2. be polite and courteous at all times to the residents of the occupied premises and will minimize noise, disruption and inconvenience to the tenants;
3. direct all tenant questions and disputes regarding the Work, to CADA Administrative Offices or the Project Manager, or Facilities Manager;
4. not engage in discussion, conversation, explanation, advice or opinion, with tenants about matters relating to personal matters;
5. consider tenants' safety, health, comfort, and security at all times;
6. not use offensive language, play loud music, or engage in loud or boisterous behavior;
7. not comment on the property or a tenant's lifestyles;
8. not smoke indoors, consume alcohol or use prohibited substances;
9. not bring visitors unrelated to the Work;
10. not bring animals or pets to the Work;
11. not mistreat a tenant's pet; and
12. not use tenants' telephones, except in cases of emergency.



**ASBESTOS-FREE MATERIALS CERTIFICATION  
TO BE EXECUTED BY AWARDED BIDDER**

HVAC UPGRADE PROJECT – 1317 O Street

The undersigned declares that he or she is the person who executed the bid for the HVAC UPGRADE PROJECT – Contract # C24-\_\_\_ (hereinafter referred to as the “Project”), and submitted it to the CAPITOL AREA DEVELOPMENT AUTHORITY (hereinafter referred to as “Authority”) on behalf of \_\_\_\_\_ (hereinafter referred to as the “Contractor”).

To the best of my knowledge, information and belief, in completing the Contractor’s Work for the Project, no material furnished, installed or incorporated into the Project will contain, or in itself be composed of, any materials listed by the federal or state EPA or federal or state health agencies as a hazardous material.

Any disputes involving the question of whether or not material installed with asbestos-containing equipment is settled by electron microscopy; the cost of any such tests shall be paid by the Contractor.

All work or materials installed by the Contractor which is found to contain asbestos, or work or material installed with asbestos-containing equipment, will be immediately rejected and this work shall be removed and replaced by the Contractor at no additional cost to the Authority.

Decontamination and removal of work found to contain asbestos or work installed with asbestos-containing equipment shall be done only under supervision of a qualified consultant, knowledgeable in the field of asbestos abatement and accredited by the Environmental Protection Agency. The ASBESTOS REMOVAL CONTRACTOR shall be a Cal/OSHA registered contractor qualified in the removal of asbestos and shall be chosen and approved by a Cal/OSHA certified Asbestos Consultant who shall have sole discretion and final determination in this matter. The asbestos consultant shall be chosen and approved by the Authority who shall have sole discretion and final determination in this matter. The work will be not accepted until asbestos contamination is reduced to levels deemed acceptable by the Asbestos Consultant.

I declare under penalty of perjury under the laws of the State of California that the foregoing is true and correct.

Executed on this \_\_\_\_ day of \_\_\_\_\_, 2023 at \_\_\_\_\_.

\_\_\_\_\_  
Signature of Contractor

\_\_\_\_\_  
Name of Contractor (*Print or Type*)

[Required notary acknowledgement on following page]

**Acknowledgment**

A notary public or other officer completing this certificate verifies only the identity of the individual who signed the document to which this certificate is attached, and not the truthfulness, accuracy, or validity of that document.

State of California )  
County of Sacramento )

On \_\_\_\_\_, before me, \_\_\_\_\_, a Notary

Public, personally appeared \_\_\_\_\_, who proved to me on the basis of satisfactory evidence to be the person(s) whose name(s) is/are subscribed to the within instrument and acknowledged to me that he/she/they executed the same in his/her/their authorized capacity(ies), and that by his/her/their signature(s) on the instrument the person(s), or the entity upon behalf of which the person(s) acted, executed the instrument.

I certify under PENALTY OF PERJURY under the laws of the State of California that the foregoing paragraph is true and correct.

WITNESS my hand and official seal.

Signature \_\_\_\_\_ (Seal)

**RECYCLED CONTENT CERTIFICATION**

HVAC UPGRADE PROJECT – 1317 O Street

The undersigned declares that he or she is the person who executed the bid for the HVAC UPGRADE PROJECT – Contract # C24-\_\_\_\_ (hereinafter referred to as the “Project”), and submitted it to the CAPITOL AREA DEVELOPMENT AUTHORITY (hereinafter referred to as “Authority”) on behalf of \_\_\_\_\_ hereinafter referred to as the “Contractor”).

Pursuant to Public Contract Code section 22152, the Contractor shall certify in writing under penalty of perjury, the minimum, if not exact, percentage of post-consumer material as defined in the Public Contract Code section 12200, in products, materials, goods, or supplies offered or sold to Authority. With respect to printer or duplication cartridges that comply with the requirements of Section 12156(e), the certification required by this subdivision shall specify that the cartridges so comply (Public Contract Code § 22152).

I declare under penalty of perjury under the laws of the State of California that all of the foregoing is true and correct.

Executed at \_\_\_\_\_ this \_\_\_\_ day of \_\_\_\_\_, 2023.

(City and State)

\_\_\_\_\_  
(Signature)

\_\_\_\_\_  
(Handwritten or Typed Name)